



ADV

Wind Cooler (standard form)

风冷却器 (标准型)



ADV

Wind Cooler Series

Enumeration of wind cooler models 风冷却器型号说明

DELA - 4 - 4 - A - T - 55 - 0 - Ex - SX - R
1 2 3 4 5 6 7 8 9 10

1. Serial number

DEL, DELA, DELH, DET, DEQ, DEK, EC

2. Models of Cooler

1, 2, 3, 3B, 4, 4B, 5, 6, 7, 8, 9, 10, 11

3. Rotation rate of wind vane

2P 3000rpm =2 6P 1000rpm =6
 4P 1500rpm =4 8P 750rpm =8

4. Voltage and frequency

3φ 220/380V 50Hz	=A
3φ 380/660V 50Hz	=B
3φ 660/1140V 50Hz	=C
3φ 220-240/380-420V 50Hz; 440/480V 60Hz	=E
2φ 110V	=H
2φ 220V	=I
2φ 380V	=J
DC 12V	=K
DC 24V	=L
Others (to be introduced verbally)	=***

5. Built-in bypass-valve

Temperature bypass-valve (45-55°C)	=T
Pressure bypass-valve (5 Bar)	=P
None	=0
Others (to be introduced verbally)	=X

6. Temperature switch

45°C = 45, 55°C = 55, 65°C = 65, 75°C = 75, None = 00

7. Directions of entry & exit

Lower left entry, right upper exit, facing the radiator	=0
Lower right entry, left upper exit, facing the radiator	=1
Special	=Z

8. Applicable working conditions

Not explosion-proof	=None
Exd I explosion-proof (not digging side)	=Ex
Exd II explosion-proof (explosion-proof symbols to be introduced verbally)	=Ex II

9. Direction of wind

Wind-inhaling = None Wind-blowing = CF Bidirectional = SX

10. Radiating process

One-way process= None Two-way process=R

Attention: If special requirements are needed, please tell us verbally.

- All series of products by our company can be equipped with temperature bypass-valves or pressure bypass-valves, which are welcome to be selected.
- When you are choosing a model, please tell us the environmental temperature and altitude where the cooler will work, so that we can help you choose it correctly.

1. 系列号

DEL, DELA, DELH, DET, DEQ, DEK, EC

2. 冷却器型号

1, 2, 3, 3B, 4, 4B, 5, 6, 7, 8, 9, 10, 11

3. 风叶转速数

2P 3000rpm =2 6P 1000rpm =6
 4P 1500rpm =4 8P 750rpm =8

4. 电压和频率

3φ 220/380V 50Hz	=A
3φ 380/660V 50Hz	=B
3φ 660/1140V 50Hz	=C
3φ 220-240/380-420V 50Hz; 440/480V 60Hz	=E
2φ 110V	=H
2φ 220V	=I
2φ 380V	=J
DC 12V	=K
DC 24V	=L
其他(用明语说明)	=***

5. 内置旁通阀

温度旁通阀(45-55°C)	=T
压力旁通阀(5 Bar)	=P
无	=0
其他(用明语说明)	=X

6. 温度开关

45°C = 45, 55°C = 55, 65°C = 65, 75°C = 75, None = 00

7. 进出口方向

面对散热器, 左下进口, 右上出口	=0
面对散热器, 右下进口, 左上出口	=1
特殊	=Z

8. 适用工况

非防爆	=无
Exd I 类防爆 (非采掘面)	=Ex
Exd II 类防爆 (用明语说明防爆标志)	=Ex II

9. 风向

吸风式 = 无 吹风式 = CF 双向 = SX

10. 散热流程

单流程 = 无 双流程 = R

注: 如有其他特殊要求请用明语说明!

- 我公司全系列标准产品, 均可选配内置温度旁通阀或压力旁通阀, 欢迎选配
- 选型时请告知您的使用环境温度 and 海拔高度, 以便我们为正确选型

» Heat abstraction quantity curve of DEL. DELA. DELH 散热量曲线

» Pressure drop curve of DEL. DELA. DELH 压力损失曲线

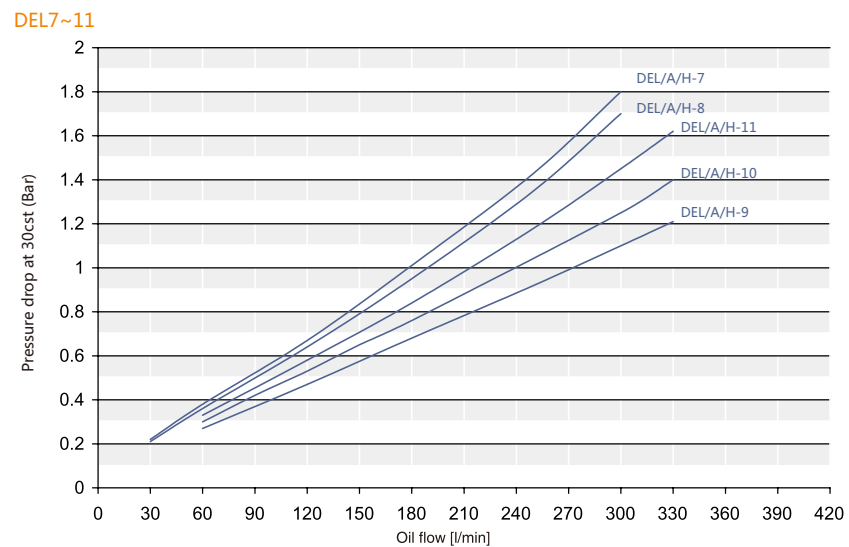
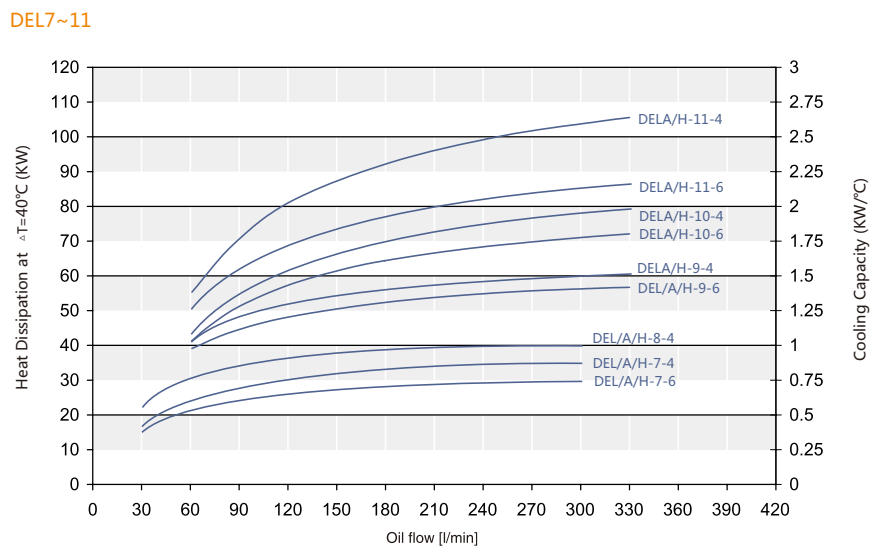
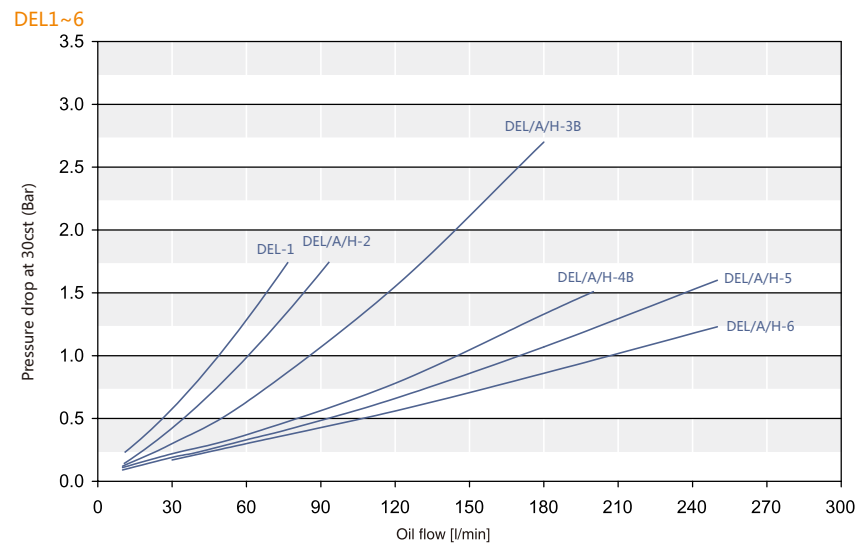
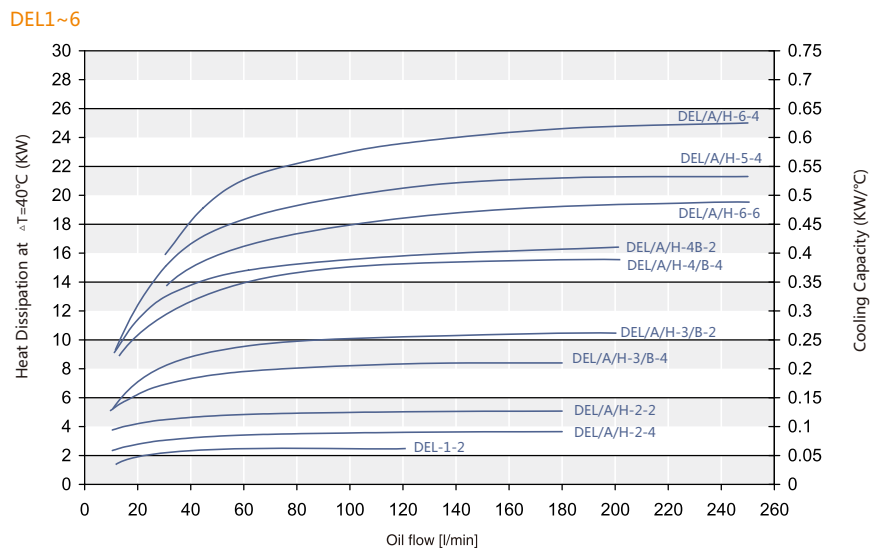

DEL series Coolers applied to indoor hydraulic and lubricating systems 液压系统、润滑系统等室内用冷却器



Mainly use for :
General hydraulic system, lubricating system, gearbox (large reduction box) and so on in indoor enviroment.

Technical data (DEL-1~DEL-8)
Maximum static pressure:
16 Bar (ones of higher pressure can be custom made)
Rated inlet tempreture:
70 °C (below 130 °C can be custom made)

DEL主要运用于：
一般液压系统、润滑系统、齿轮箱
(大型减速机)等室内工作环境

技术参数：
最大静态压力：16Bar (更高压力接受定制)
额定入口温度：70°C (130°C以下可订制)

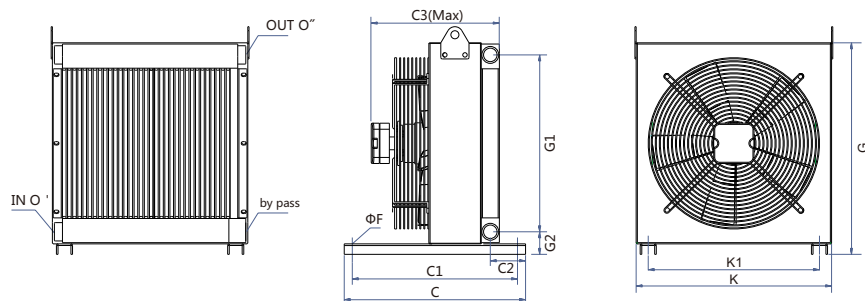

Dimensions 外形尺寸 Make sure you can select the right cooler, please contact us * 为保证冷却器选型的准确性, 请与迪奥公司电话联系。

Type 型号	G ±10	K ±10	C ±2	G1 ±5	G2 ±5	K1 ±2	C1 ±2	C2 ±5	C3 ±5	O'	O''	ΦF
DEL1	356	226	135	289	/	206	70	/	135	G3/4"	G3/4"	9
DEL2	356	335	296	289	43	160	255	58	240	G3/4"	G3/4"	9*12
DEL3B	456	385	296	389	43	290	255	63	300	G3/4"	G3/4"	9*12
DEL4B	525	486	450	439	56	425	410	78	345	G1"	G1"	9*20
DEL5	565	545	450	479	56	482	410	78	345	G1"	G1"	9*20
DEL6	645	585	450	500	86	482	410	78	345	G1-1/4"	G1-1/4"	9*20
DEL7	738	708	500	630	70	560	460	98	420	G1-1/4"	G1-1/4"	9*20
DEL8	866	700	500	760	68	560	460	98	420	G1-1/4"	G1-1/4"	9*20

Technical data of DEL 技术参数

Type 型号	Comparative Cooling Capacity [kW/°C] 比较热量	Suggested Flux [L/min] 建议流量	Fan Diameter [mm] 风扇直径	Fan speed [rpm] 风扇转速	Noise level [dB(A), 1m] 噪声	Motor Voltage [V] 电机电压	Consumed Power [kW] 消耗功率	Working Pressure [bar] 工作压力
DEL1	0.05	5~40	150	2600	63	AC220	0.04*2	16
			150	2600	63	AC380	0.04*2	16
			150	2600	63	DC24	0.04*2	16
			150	2600	63	DC12	0.04*2	16
DEL2	0.10	10~60	250	1380	76	AC110	0.12	16
			250	2600	76	AC220	0.06	16
			250	2600	76	AC380	0.06	16
			250	3000	78	DC12	0.1	16
			250	3000	78	DC24	0.1	16
DEL3B	0.16	15~100	300	1380	66	AC110	0.21	16
			300	2600	66	AC220	0.08	16
			300	2600	66	AC380	0.08	16
			300	3000	78	DC12	0.2	16
			300	3000	78	DC24	0.2	16
DEL4B	0.34	15~120	400	1380	73	AC220	0.18	16
			400	1380	73	AC380	0.18	16
			385	3000	82	DC12	0.2	16
			385	3000	82	DC24	0.2	16
DEL5	0.46	20~170	450	1360	78	AC220	0.25	16
			450	1360	78	AC380	0.25	16
			385	3000	82	DC12	0.2	16
			385	3000	82	DC24	0.2	16
DEL6	0.6	20~180	500	1300	81	AC220	0.45	16
			500	1300	81	AC380	0.45	16
			250	3000	82	DC12	0.1*2	16
			250	3000	82	DC24	0.1*2	16
DEL7	0.7	50~200	500	1300	81	AC220	0.45	16
			500	1300	81	AC380	0.45	16
			280	3000	82	DC12	0.12*4	16
			280	3000	82	DC24	0.12*4	16
DEL8	0.78	50~180	500	1300	81	AC220	0.45	16
			500	1300	81	AC380	0.45	16
			280	3000	82	DC12	0.12*4	16
			280	3000	82	DC24	0.12*4	16

In order to avoid cracking , when a cooler is installed in the return oil circuit, a bypass unloading valve must be parallelly connected. And make sure the unloading valve can be opened preferentially when the decompression valve reaches the pressure peak. If there is a pulse in the return oil of system or the oil flow is very big, suggest to choose the self-circulating cooling system from Deo, so that you can keep the whole system stable and reliable.

为保护冷却器不致破裂, 当冷却器安装于回油回路时, 必需加装旁通卸载阀, 与冷却器并联, 并且确认泄压阀遭遇压力峰值时, 能够优先打开卸载。如果系统回油有脉冲或者流量很大, 建议选用迪奥自循环冷却系统, 以保证整个系统的稳定和可靠。

DELTA series Firm and reliable cooler used outdoors 结实可靠的户外用冷却器



Mainly use for :
Vessel equipments, wind electricity-generating equipments, extracting equipments in mines working in severe environments whose protection class is above IP55, which are outdoor, explosion-proof, water-proof, dirt-proof.

- Features:**
- Capable of a chieving explosion-proof standard requirements.
 - Of high-quality metal plate structure completely through numerical control machining.
 - Imported electrical motor , wind blades are reliable-quality with good-looking appearance.
 - Processed by flame plating of phosphorization plus static electricity at the surface , having excellent anticorrosion performance.

DELTA主要运用于:
防护等级IP55以上, 户外工作, 防爆、防水、防尘, 环境较差的场合。
如: 船舶设备、风力发电设备、矿山开采设备

- 特点介绍:**
- 可达到防爆的标准要求;
 - 高品质钣金结构件, 全部数控加工;
 - 进口电机, 风叶质量可靠, 外型美观;
 - 表面磷化加静电喷涂处理, 防腐性能优越。

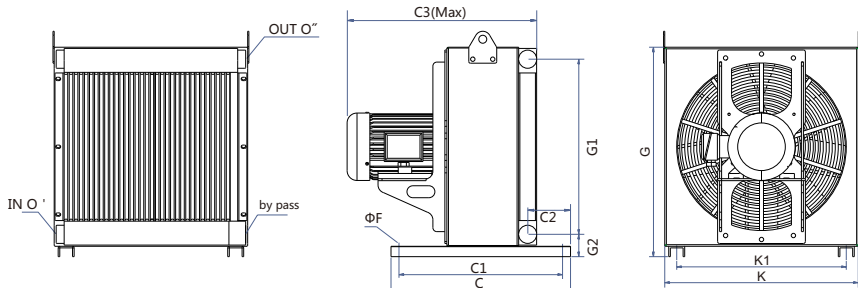

Dimensions 外形尺寸

Make sure you can select the right cooler, please contact us ※ 为保证冷却器选型的准确性, 请与迪奥奥公司电话联系。

Type 型号	G ±10	K ±10	C ±2	G1 ±5	G2 ±5	K1 ±2	O1 ±2	O2 ±5	C3 ±5	O'	O''	ΦF
DELA2	366	335	400	289	43	160	360	58	385	G3/4"	G3/4"	9*12
DELA3B	466	385	450	389	43	290	410	66	430	G3/4"	G3/4"	9*12
DELA4B	525	486	450	439	56	425	410	98	495	G1"	G1"	9*20
DELA5	565	545	450	479	56	482	410	98	500	G1"	G1"	9*20
DELA6	645	585	450	500	86	482	410	98	500	G1-1/4"	G1-1/4"	9*20
DELA7	738	708	500	630	70	560	460	98	540	G1-1/4"	G1-1/4"	9*20
DELA8	866	700	500	760	68	560	460	98	550	G1-1/4"	G1-1/4"	9*20
DELA9	880	790	700	770	75	700	660	119	676	G1-1/2"	G1-1/2"	14*23
DELA10	1040	930	700	890	95	700	660	113	710	G1-1/2"	G1-1/2"	14*23
DELA11	1220	1050	700	1060	100	700	660	113	780	G1-1/2"	G1-1/2"	14*23

Technical data of DELTA 技术参数

Type 型号	Comparative Cooling Capacity [kW/°C] 比焓热量	Suggested Flux [L/min] 建议流量	Fan Diameter [mm] 风扇直径	Fan speed [rpm] 风扇转速	Noise level [dB(A), 1m] 噪声	Motor Voltage [V] 电机电压	Consumed Power [kW] 消耗功率	Working Pressure [bar] 工作压力
DELA2	0.15	10-60	250	3000	80	3Φ380	0.55	16
	0.10		250	1500	66		0.25	16
DELA3B	0.30	15-100	300	3000	85		0.55	16
	0.18		300	1500	66		0.25	16
DELA4B	0.42	15-120	400	3000	86		1.1	16
	0.38		400	1500	74		0.55	16
DELA5	0.52	20-170	450	1500	75		0.55	16
DELA6	0.65	20-180	500	1500	78		0.75	16
	0.45		500	1000	67		0.55	16
DELA7	0.85	50-200	630	1500	84		1.5	16
	0.72		630	1000	76		0.75	16
DELA8	1.15	50-180	630	1500	84	2.2	16	
	0.91		630	1000	77	0.75	16	
DELA9	1.82	50-250	700	1500	87	2.2	16	
	1.60		700	1000	77	1.5	16	
DELA10	1.93	50-280	800	1500	92	5.5	16	
	1.72		800	1000	80	3	16	
DELA11	2.8	50-300	900	1500	98	5.5	16	
	2.3		900	1000	88	4	16	

Technical data (DELA-2~DELA-11)

Maximum static pressure:
16 Bar (ones of higher pressure can be custom made)
Rated inlet temperature:
70 °C (below 130 °C can be custom made)

In order to avoid cracking, when a cooler is installed in the return oil circuit, a bypass unloading valve must be parallelly connected. And make sure the unloading valve can be opened preferentially when the decompression valve reaches the pressure peak. If there is a pulse in the return oil of system or the oil flow is very big, suggest to choose the self-circulating cooling system from Deo, so that you can keep the whole system stable and reliable.

DELA-2 ~ DELA-11技术参数

最大静态压力: 16Bar(更高压力接受定制)
额定入口温度: 70°C (130°C以下可订制)

为保护冷却器不致破裂, 当冷却器安装于回油回路时, 必需加装旁通卸载阀, 与冷却器并联, 并且确认泄压阀遭遇压力峰值时, 能够优先打开卸载。如果系统回油有脉冲或者流量很大, 建议选用迪奥自循环冷却系统, 以保证整个系统的稳定和可靠。

DELH series Hydraulic motor driven oil cooler 液压马达驱动油冷却器



Mainly used for :
All kinds of movable hydraulic system or situations without large power supply of AC power.

Features:

- Patented exterior design
- Of high-quality metal plate structure completely through numerical control machining.
- Imported electrical motor, wind blades of reliable-quality with good-looking appearance.
- Processed by flame plating of phosphorization plus static electricity at the surface, having excellent anticorrosion performance.

DELH主要运用于：

各种移动式液压系统或现场无交流电源的大功率场合。

特点介绍：

- 专利外型设计；
- 高品质钣金结构件，全部数控加工；
- 进口风叶，质量可靠，外型美观；
- 表面磷化加静电喷涂处理，防腐性能优越；

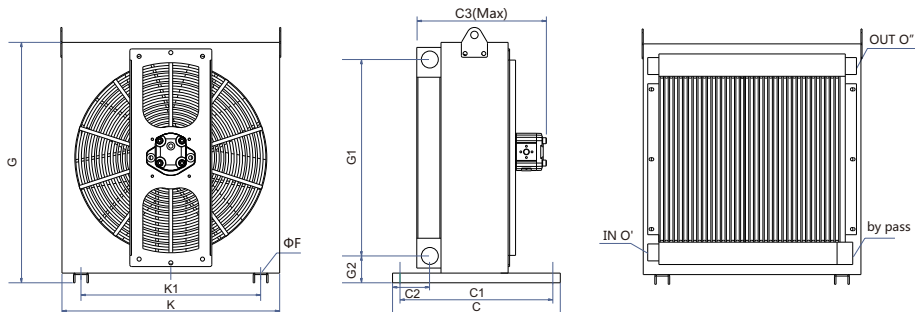

Dimensions 外形尺寸

Make sure you can select the right cooler, please contact us ※ 为保证冷却器选型的准确性，请与迪奥公司电话联系。

Type 型号	G ±10	K ±10	C ±2	G1 ±5	G2 ±5	K1 ±2	C1 ±2	C2 ±5	C3 ±5	O'	O''	ΦF
DELH2	366	335	400	289	43	160	360	58	385	G3/4"	G3/4"	9*12
DELH3B	466	385	450	389	43	290	410	66	430	G3/4"	G3/4"	9*12
DELH4B	525	486	450	439	56	425	410	98	355	G1"	G1"	9*20
DELH5	565	545	450	479	56	482	410	98	355	G1"	G1"	9*20
DELH6	645	585	450	500	86	482	410	98	355	G1-1/4"	G1-1/4"	9*20
DELH7	738	708	450	630	70	560	410	98	375	G1-1/4"	G1-1/4"	9*20
DELH8	866	700	450	760	68	560	410	98	375	G1-1/4"	G1-1/4"	9*20
DELH9	880	790	520	770	75	700	480	119	600	G1-1/2"	G1-1/2"	14*23
DELH10	1040	930	520	890	95	700	480	113	610	G1-1/2"	G1-1/2"	14*23
DELH11	1220	1050	520	1060	100	700	480	113	630	G1-1/2"	G1-1/2"	14*23

Technical data of DELH 技术参数

Type 型号	Cooling Capacity [KW/°C] 比散热量	Traffic [L/min] 建议流量	Fan Diameter [mm] 风扇直径	Fan speed [rpm] 风扇转速	Noise level [dB(A), 1m] 噪声	Displacement Hydraulic Motor [ccm] 液压马达排量	Motor Working Pressure [Mpa] 马达工作压力	Working Pressure [bar] 工作压力
DELH2	0.15	10-60	250	3000	80	8	10~16	16
DELH3B	0.3	15-100	300	3000	85	8	10~16	16
DELH4B	0.42	15-120	400	3000	86	8	10~16	16
DELH5	0.52	20-150	450	1500	75	8	10~16	16
DELH6	0.65	20-180	500	1500	75	16	10~16	16
DELH7	0.85	50-200	630	1500	78	16	10~16	16
DELH8	1.15	50-180	630	1500	84	16	10~16	16
DELH9	1.82	50-250	700	1000	87	25	10~16	16
DELH10	1.93	50-280	800	1000	92	25	10~16	16
DELH11	2.8	50-300	900	1000	98	25	10~16	16

Technical data :

Maximum static pressure: 16 Bar (ones of higher pressure can be custom made)
Rated inlet temperature: 70 °C (below 130 °C can be custom made)

In order to avoid cracking , when a cooler is installed in the return oil circuit, a bypass unloading valve must be parallelly connected. And make sure the unloading valve can be opened preferentially when the decompression valve reaches the pressure peak. If there is a pulse in the return oil of system or the oil flow is very big, suggest to choose the self-circulating cooling system from Deo, so that you can keep the whole system stable and reliable.

DELH技术参数：

最大静态压力：16Bar(更高压力接受定制)
额定入口温度：70°C (130°C以下可订制)

为保护冷却器不致破裂，当冷却器安装于回油回路时，必需加装旁通卸载阀，与冷却器并联，并且确认泄压阀遭遇压力峰值时，能够优先打开卸载。如果系统回油有脉冲或者流量很大，建议选用迪奥自循环冷却系统，以保证整个系统的稳定和可靠。

DET series Applied to construction machinery 工程机械用



Features

- Highly efficient cooling systems made of Aluminium.
 - High performance and working pressure-even for heavy duty of hydraulic or lubrication applications.
 - Maximum working pressure
DET1-DET8 16bar
DET9-DET11 10bar
 - Wide application to transmission systems, engines, hydraulic and lubricating systems etc. They may also act as independent coolers.
 - This model of cooler can be collocated with 12V/24V DC generator, 220V/380V AC generator or fans driven by hydraulic motors.
- 特点：**
- 铝质高效冷却系统
 - 性能卓越，可承受高工作压力—重载液压或润滑系统亦可使用
 - 最高工作压力：DET1~DET8 16bar
DET9~DET11 10bar
 - 应用场合广泛，如传输系统、发动机，液压及润滑系统等，也可用作独立的冷却器
 - 可配置12V/24V直流电机，220V/380V交流电机或液压马达驱动风扇

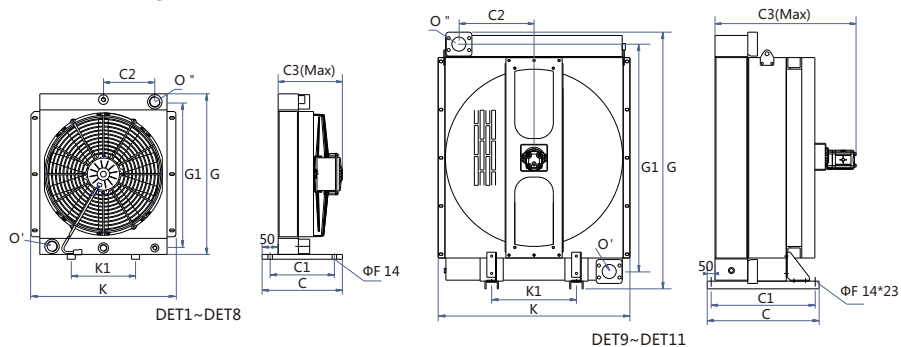

Dimensions 外形尺寸

Make sure you can select the right cooler, please contact us ※ 为保证冷却器选型的准确性，请与迪奥公司电话联系。

Type 型号	Heat Rejection (KW) 散热量	G ±10	K ±10	C ±2	C1 ±2	C2 ±5	C3 ±5	G1 ±5	K1 ±2	O/O*
DET1	1-5	325	250	200	150	65	170	260	80	G3/4"
DET2	3-10	415	360	250	200	115	330	350	150	G1"
DET3	8-15	520	455	250	200	160	330	450	200	G1"
DET4	10-20	520	455	300	250	160	330	460	200	G1 3/4"
DET5(DET5K)	15-25	695	471	300	250	165	445(415)	610	200	G1 3/4"(G1")
DET6	20-35	795	610	300	250	235	495	710	310	G1 3/4"
DET7	35-40	950	610	300	250	235	525	860	310	G1 3/4"
DET8	35-75	960	725	300	250	280	580	870	400	G1 1/2"
DET9	60-120	1340	1000	580	540	390	710	1180	440	FL65
DET10	85-180	1340	1000	580	540	390	730	1180	440	FL80
DET11	120-260	1482	1290	850	810	532	850	1330	525	FL80

Technical data of DET 技术参数

Type 型号	Fan Diameter [mm] 风扇直径	Fan speed [rpm] 风扇转速	Noise level [dB(A), 1m] 噪声	Motor Voltage [V] 电机电压	Consumed Power [kW] 消耗功率	Volume [l] 容量	Working Pressure [bar] 工作压力	Total Weight excluding fluid [kg] 总重量(不含液体)
DET1	190	3250	71	12	0.08	1.0	16	6.7
	190	3250	71	24	0.08	1.0	16	6.7
	200	2750	64	230/400	0.05	1.0	16	7.1
DET2	255	2600	74	12	0.1	1.9	16	15.6
	255	2600	72	24	0.1	1.9	16	15.6
	250	3000	75	Hydraulic motor		1.9	16	15.6
	250	1500	57	230/400	0.06	1.9	16	15.6
	250	1500	65	*230/400	0.25	1.9	16	15.6
DET3	350	2950	76	12	0.2	2.9	16	23
	350	2950	78	24	0.2	2.9	16	23
	380	1500	75	Hydraulic motor		2.9	16	23
	380	1000	68	234/400	0.14	2.9	16	23
	350	1500	75	*230/400	0.25	2.9	16	23
DET4	350	2950	77	12	0.2	5.2	16	28.8
	350	2950	78	24	0.2	5.2	16	28.8
	350	1500	77	Hydraulic motor		5.2	16	28.8
	350	1500	77	230/400	0.14	5.2	16	28.8
	350	1500	77	*230/400	0.37	5.2	16	28.8
DET5	385	3100	79	12	0.2	6.3	16	38
	385	3100	79	24	0.2	6.3	16	38
	450	1500	77	Hydraulic motor		6.3	16	38
	450	1500	77	230/400	0.25	6.3	16	38
DET5K	450	1500	77	*230/400	0.55	5.5	16	38
	450	1500	77					
DET6	2x305	3100	81	12	2x0.2	8.5	16	49
	2x305	3100	81	24	2x0.2	8.5	16	49
	500	1500	79	Hydraulic motor		8.5	16	49
	500	1500	79	230/400	0.45	8.5	16	49
	500	1500	79	*230/400	0.75	8.5	16	49
DET7	2x305	3100	81	12	2x0.2	10.6	16	54
	2x305	3100	81	24	2x0.2	10.6	16	54
	500	1500	79	Hydraulic motor		10.6	16	54
	500	1500	79	230/400	0.45	10.6	16	54
	500	1500	79	*230/400	0.75	10.6	16	54
DET8	4x305	3100	81	12	4x0.2	17.7	16	89
	4x305	3100	81	24	4x0.2	17.7	16	89
	630	1000	79	Hydraulic motor		17.7	16	89
	630	1000	79	*230/400	0.75	17.7	16	89
	630	1500	90	*230/400	2.2	17.7	16	89
DET9	900	1000	88	Hydraulic motor		25	10	190
	900	1000	88	*230/400	2.2	25	10	190
	900	750	82	*230/400	1.1	25	10	190
DET10	900	1000	98	Hydraulic motor		31	10	200
	900	1500	98	*400/690	5.5	31	10	200
	900	1000	88	*400/690	3.0	31	10	200
DET11	1000	1000	100	Hydraulic motor		55	10	约290
	1000	1500	100	*400/690	11.0	55	10	约290
	1000	1000	90	*400/690	7.5	55	10	约290

Displacement of hydraulic motor [cm³]

DET2~DET5 : 8ccm
DET6~DET8 : 16ccm
DET9~DET10 : 25ccm

液压马达排量 [cm³]:

DET2~DET5 : 8ccm
DET6~DET8 : 16ccm
DET9~DET10 : 25ccm

* Motor 电机

Quick model selection of DET 快速选型

Quick selection can be made with the help of the following tables

The data of heat abstraction quantity in the forms below are based on the assumption that oil inlet temperature does not exceed 70°C for hydraulic systems and 110°C for lubricating systems.

Please use the following heat abstraction figures if no details are available:
 - Agricultural and construction machinery: 1/3 of diesel engine power
 - Hydraulic pumps driven by an electric motor: 1/3 of electric motor power

借助以下表格可进行快速选型

下表中给出的散热量数据是在下述条件下求得的:
 1. 液压系统进口温度不超过70°C
 2. 润滑系统进口温度不超过110°C

若无详细散热量参数, 可按下列方法估算散热量:
 - 农业及建筑机械: 柴油机功率的1/3
 - 电机驱动的液压泵: 电机功率的1/3

Applied to hydraulic systems 应用于液压系统

Heat rejection [kW @40°C ambient temperature] 环境温度30°C时的散热量 (kW)													
Oil flow in 油流量 (L/min)	DET1	DET2	DET3	DET4	DET5K	DET5	DET6	DET7	DET8	DET8S	DET9	DET10	DET11
10	1.5	3.4	5										
20	2.2	4.6	6	6	11								
30	3	5.4	7	8.5	13								
50	3.5	6.3	8.5	10	12.6	16	20	24	28	34			
75		7	10	11	15	17	23	26	31	31	46	60	
100		7.6	11	12	16	18	24	27	33	42	52	84	
150			12	13	17	20	25	29	36	47	61	96	131
200						21	26	30	37	51	68	105	147
250									38	54	72	111	159
300											75	117	171
400											83	126	186
500											89	135	200
600													210

Applied to lubricating systems 应用于润滑系统

Heat rejection [kW @40°C ambient temperature] 环境温度40°C时的散热量 (kW)													
Oil flow in 油流量 (L/min)	DET1	DET2	DET3	DET4	DET5K	DET5	DET6	DET7	DET8	DET8S	DET9	DET10	DET11
10	3.5	7	11										
20	5.5	10	14	14	27								
30	7	12	17	20	30	31							
50	8	14	20	23	32	37	48	56	69	81			
75	9	16	22	27	35	40	53	60	73	91	107		
100		18	24	29	37	43	55	63	77	98	121	196	
150			28	32	40	46	59	67	84	110	142	224	301
200						49	62	70	88	119	158	245	343
250									90	126	168	259	371
300											175	273	399
400											193	294	434
500											207	315	466
600													490

Heat abstraction quantity curve & pressure loss of DET 散热量曲线和压力损失

Curve of heat abstraction quantity 散热量曲线
DET1~DET8

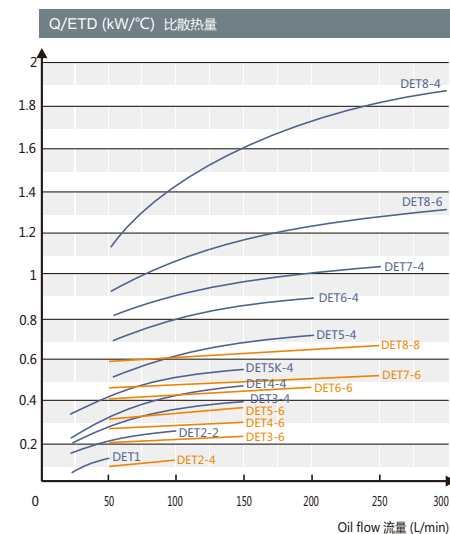

Curve of heat abstraction quantity 散热量曲线
DET9~DET11

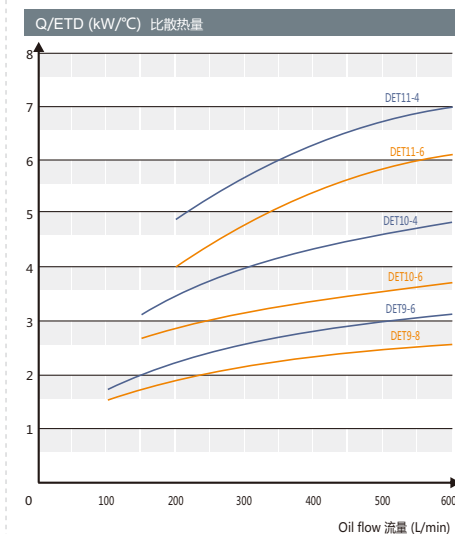

Pressure loss 压力损失
DET1~DET8

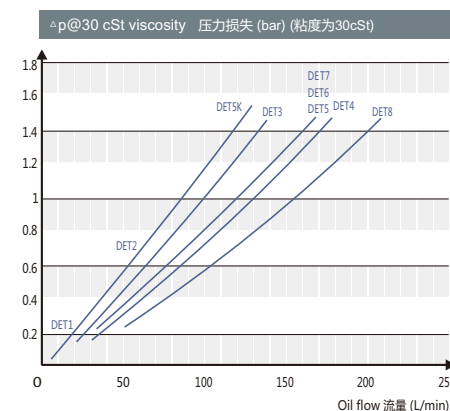

Pressure loss 压力损失
DET9~DET11

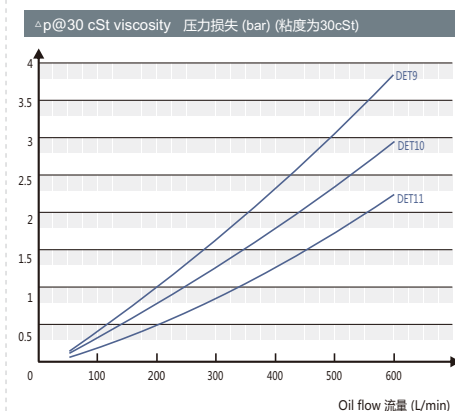

DEQ series

Suitable for outdoor, oceanic, explosion-proof and other environment
户外、海洋、防爆等环境适用



Mainly used for:
Severe outdoor occasions requested to be explosion-proof, water proof, where protection class in over IP55. For example, vessel equipments wind-generating equipments, exploiting equipments in diggings.

Technical data:
Maximum static pressure:
16 Bar (ones of higher pressure can be custom made)
Rated inlet temperature:
70 °C (below 130 °C can be custom made)

DEQ主要运用于:
防护等级IP55以上, 户外工作,
防爆、防水、防尘, 环境较差
的场所。如: 船舶设备、风力
发电设备、矿山开采设备。

技术参数:
最大静态压力:
16Bar(更高压力接受定制)
额定入口温度:
70°C (130°C以下可订制)

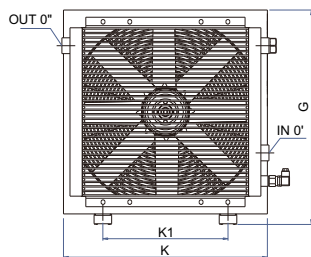
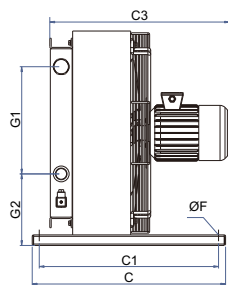

Dimensions 外形尺寸

Make sure you can select the right cooler, please contact us ※ 为保证冷却器选型的准确性, 请与迪奥公司电话联系。

Type 型号	G ±10	K ±10	C ±2	C1 ±2	C2 ±5	C3 ±5	G1 ±5	G2 ±5	K1 ±2	O'	O*	ΦF
DEQ-007	395	365	550	510	225	435	160	132	203	G 1"	G 1"	9*20
DEQ-011	470	440	550	510	249	493	230	136	203	G 1"	G 1"	9*20
DEQ-016	526	496	550	510	272	480	230	197	203	G 1"	G 1"	9*20
DEQ-023	610	580	550	510	287	529	305	204	356	G 1"	G 1"	9*20
DEQ-033	722	692	550	510	318	654	406	213	356	G 1-1/4"	G 1-1/4"	9*20
DEQ-044	866	692	550	510	343	679	584	196	356	G 1-1/4"	G 1-1/4"	9*20
DEQ-056	898	868	550	510	368	704	584	212	508	G 1-1/4"	G 1-1/4"	9*20
DEQ-058	898	868	550	510	387	723	584	212	508	G 2"	G 2"	9*20
DEQ-076	1052	1022	840	800	393	712	821	131	518	G 1-1/2"	G 1-1/2"	14*23
DEQ-078	1052	1022	840	800	413	732	821	131	518	G 2"	G 2"	14*23
DEQ-110	1215	1185	840	800	418	842	985	130	600	G 2"	G 2"	14*23
DEQ-112	1215	1185	840	800	438	862	985	130	600	G 2"	G 2"	14*23
DEQ-113	1215	1200	840	800	468	892	985	130	600	G 2"	G 2"	14*23

Technical data of DEQ 技术参数

Type 型号	Comparative Cooling Capacity [kW/°C] 比较热量	Suggested Flux [L/min] 建议流量	Fan Diameter [mm] 风扇直径	Fan speed [rpm] 风扇转速	Noise level [dB(A), 1m] 噪声	Motor Voltage [V] 电机电压	Consumed Power [kW] 消耗功率	Working Pressure [bar] 工作压力
DEQ-007-2	0.2	10-60	300	3000	79	3Φ380	0.55	16
DEQ-007-4	0.14			1500	62		0.25	16
DEQ-011-2	0.3	15-100	400	3000	82		1.1	16
DEQ-011-4	0.18			1500	67		0.25	16
DEQ-016-2	0.42	15-120	450	3000	86		1.1	16
DEQ-016-4	0.38			1500	70		0.37	16
DEQ-023-4	0.58	20-150	500	1500	76		0.75	16
DEQ-023-6	0.47			1000	64		0.55	16
DEQ-033-4	0.89	40-200	630	1500	84		2.2	16
DEQ-033-6	0.72			1000	74		0.75	16
DEQ-044-4	1.15	50-190	630	1500	85		2.2	16
DEQ-044-6	0.91			1000	76		0.75	16
DEQ-056-4	1.62	50-220	800	1500	84		2.2	16
DEQ-056-6	1.35			1000	81	1.5	16	
DEQ-058-4	1.72	50-250	800	1500	85	2.2	16	
DEQ-058-6	1.4			1000	82	1.5	16	
DEQ-076-6	1.9	50-250	900	1000	86	2.2	16	
DEQ-076-8	1.53			750	79	1.1	16	
DEQ-078-6	2.1	80-300	900	1000	87	2.2	16	
DEQ-078-8	1.73			750	80	1.1	16	
DEQ-110-6	2.23	120-300	1000	1000	90	5.5	16	
DEQ-110-8	1.97			750	84	2.2	16	
DEQ-112-6	2.66	120-350	1000	1000	91	5.5	16	
DEQ-112-8	2.12			750	85	2.2	16	
DEQ-113-6	2.81	150-400	1000	1000	88	5.5	16	
DEQ-113-8	2.32			750	80	2.2	16	

In order to avoid cracking , when a cooler is installed in the return oil circuit, a bypass unloading valve must be parallelly connected. And make sure the unloading valve can be opened preferentially when the decompression valve reaches the pressure peak. If there is a pulse in the return oil of system or the oil flow is very big, suggest to choose the self-circulating cooling system from Deo, so that you can keep the whole system stable and reliable.

为保护冷却器不致破裂, 当冷却器安装于回油回路时, 必需加装旁通卸载阀, 与冷却器并联, 并且确认泄压阀遭遇压力峰值时, 能够优先打开卸载。如果系统回油有脉冲或者流量很大, 建议选用迪奥自循环冷却系统, 以保证整个系统的稳定和可靠。

» Heat abstraction quantity curve of DEQ 散热量曲线

» Pressure loss of DEQ 压力损失

007~023

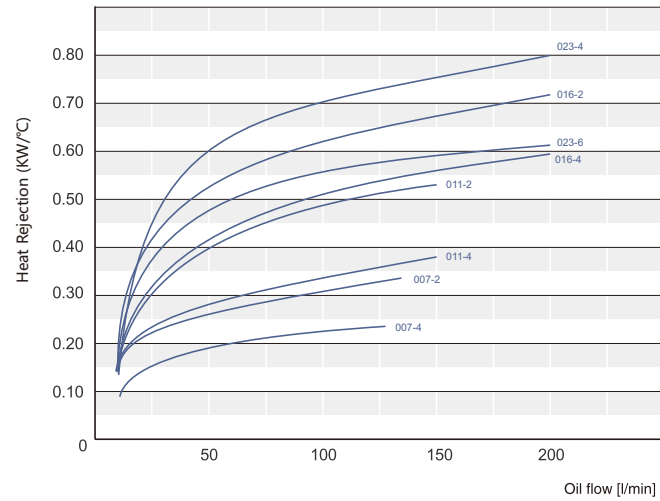

033~113

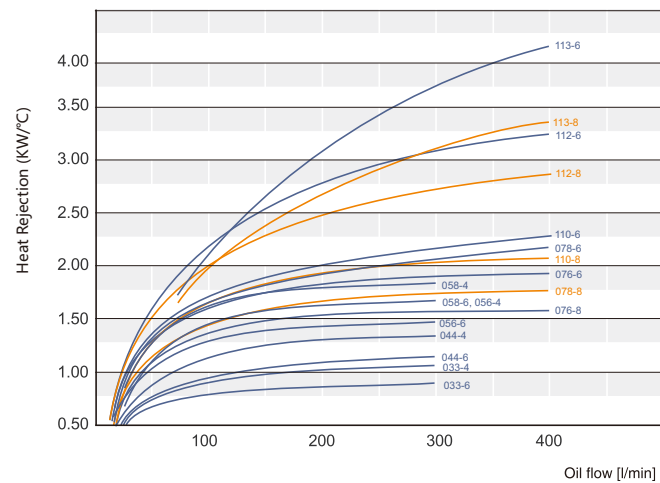

At 30 cSt single-pass

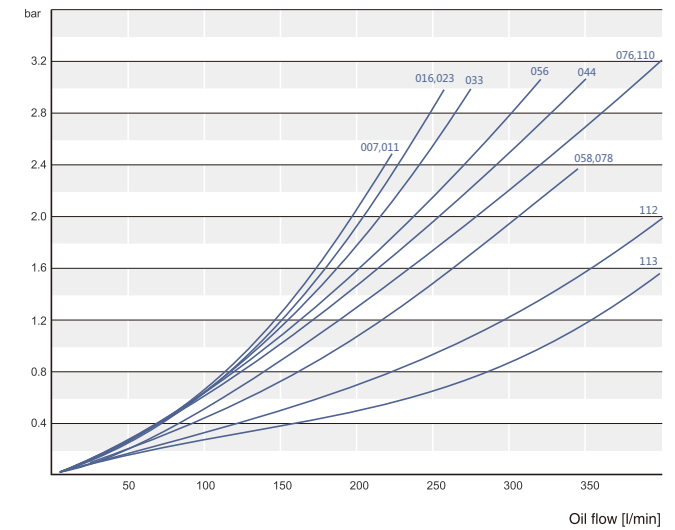

DEK series



Mainly used for:
General hydraulic and lubricating systems, gearbox (large reduction box), and so on, which work in indoor enviroment.

Technical data:
Maximum static pressure:
16 Bar (ones of higher pressure can be custom made)
Rated inlet temprature:
70 °C (below 130 °C can be custom made)

DEK主要运用于：
一般液压系统、润滑系统、齿轮箱
(大型减速机)等室内工作环境

技术参数：
最大静态压力：16Bar (更高压力接受定制)
额定入口温度：70°C (130°C以下可订制)

DEK-XX-01
DEK-XX-03

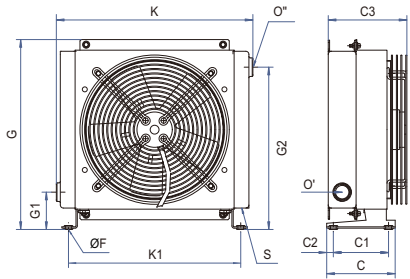

DEK-XX-04

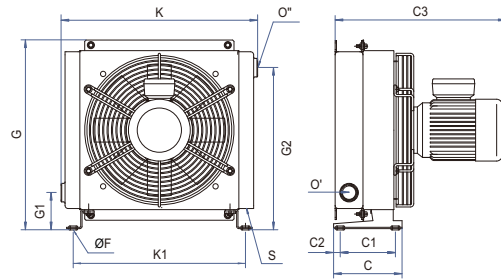

DEK-XX-12
DEK-XX-24

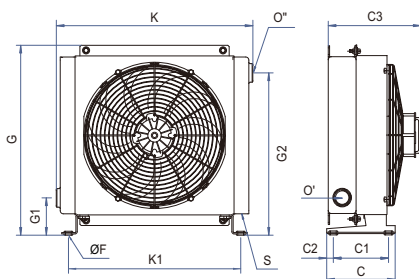

DEK-XX-56

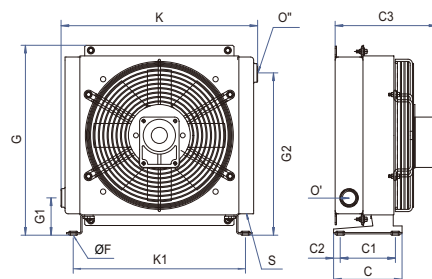

Dimensions of DEK 外形尺寸

Type 型号	G	K	C	C1	C2	C3	G1	G2	K1	F	O'	O''	S
DEK-1-01	190	146	70	/	10	116	18	173	101	Ø9	G1/2"	G1/2"	/
DEK-1-12						125							
DEK-1-24						125							
DEK-2-01	249	225	155	125	15	125	55	233	120	Ø13	G1/2"	G1/2"	/
DEK-2-12						170							
DEK-2-24						150							
DEK-3-01	305	320	155	125	15	150	83	241	273	Ø13	G1"	G1"	M14*1.5
DEK-3-03						150							
DEK-3-04						375							
DEK-3-12						170							
DEK-3-24						170							
DEK-3-56						207							
DEK-4-01	305	320	155	125	15	170	83	241	273	Ø13	G1"	G1"	M14*1.5
DEK-4-03						170							
DEK-4-04						395							
DEK-4-12						190							
DEK-4-24						190							
DEK-4-56						230							
DEK-5K-01	354	334	155	125	15	170	42.5	332	280	Ø13	G3/4"	G3/4"	M14*1.5
DEK-5K-03						170							
DEK-5K-04						395							
DEK-5K-12						195							
DEK-5K-24						195							
DEK-5K-56						230							
DEK-5-01	366	380	155	125	15	170	82	304	325	Ø13	G1"	G1"	M14*1.5
DEK-5-03						170							
DEK-5-04						395							
DEK-5-12						195							
DEK-5-24						195							
DEK-5-56						230							
DEK-6-01	430	445	155	125	15	180	85	368	390	Ø13	G1"	G1"	M14*1.5
DEK-6-03						180							
DEK-6-04						395							
DEK-6-12						231							
DEK-6-24						231							
DEK-6-56						240							
DEK-7-01	526	540	155	125	15	240	79	468	485	Ø13	G1"	G1"	M14*1.5
DEK-7-03						240							
DEK-7-04						450							
DEK-7-12						254							
DEK-7-24						254							
DEK-7-56						265							
DEK-8-01	660	600	230	180	25	275	35	635	400	Ø14	G1-1/4"	G1-1/4"	M14*1.6
DEK-8-03						275							
DEK-8-04						430							
DEK-8-12						195							
DEK-8-24						195							
DEK-8-56						265							

Make sure you can select the right cooler, please contact us ※ 为保证冷却器选型的准确性, 请与迪奥公司电话联系。

Technical data of DEK 技术参数

Type 型号	Comparative Cooling Capacity [kW/C] 比较热量	Suggested Flux [L/min] 建议流量	Fan Diameter [mm] 风扇直径	Fan speed [rpm] 风扇转速	Noise level [dB(A), 1m] 噪声	Motor Voltage [V] 电机电压	Consumed Power [kW] 消耗功率	Working Pressure [bar] 工作压力
DEK-1-01	0.05	2.5-20	120	2650	40	AC220	0.012	16
DEK-1-12	0.05		120	2500	40	DC12	0.008	16
DEK-1-24	0.05		120	2500	40	DC24	0.008	16
DEK-2-01	0.07	10-40	175	2700	63	AC220	0.05	16
DEK-2-12	0.08		190	2600	63	DC12	0.08	16
DEK-2-24	0.08		190	2600	63	DC24	0.08	16
DEK-3-01	0.12	20-80	200	2500	68	AC220	0.055	16
DEK-3-03	0.12		200	2300	68	AC380	0.055	16
DEK-3-04	0.1		200	1350	68	AC220/380	0.25	16
DEK-3-12	0.13		225	3100	72	DC12	0.1	16
DEK-3-24	0.13		225	3100	72	DC24	0.1	16
DEK-3-56	0.13		225	3000	72	/	/	16
DEK-4-01	0.14	25-100	200	2500	68	AC220	0.055	16
DEK-4-03	0.15		200	2300	68	AC380	0.055	16
DEK-4-04	0.12		200	1350	60	AC220/380	0.25	16
DEK-4-12	0.17		225	2600	72	DC12	0.1	16
DEK-4-24	0.17		225	2600	72	DC24	0.1	16
DEK-4-56	0.17		225	3000	72	/	/	16
DEK-5K-01	0.38	30-150	250	2650	70	AC220	0.08	16
DEK-5K-03	0.38		250	2650	70	AC380	0.08	16
DEK-5K-04	0.3		250	1350	60	AC220/380	0.25	16
DEK-5K-12	0.33		255	2600	72	DC12	0.1	16
DEK-5K-24	0.33		255	2600	72	DC24	0.1	16
DEK-5K-56	0.4		250	3000	72	/	/	16
DEK-5-01	0.31	30-120	250	2650	70	AC220	0.08	16
DEK-5-03	0.31		250	2650	70	AC380	0.08	16
DEK-5-04	0.26		250	1350	60	AC220/380	0.25	16
DEK-5-12	0.3		255	2600	72	DC12	0.1	16
DEK-5-24	0.3		255	2600	72	DC24	0.1	16
DEK-5-56	0.38		250	3000	72	/	/	16
DEK-6-01	0.35	35-140	300	2300	76	AC220	0.145	16
DEK-6-03	0.35		300	2300	76	AC380	0.145	16
DEK-6-04	0.27		300	1350	65	AC220/380	0.25	16
DEK-6-12	0.32		305	3100	76	DC12	0.2	16
DEK-6-24	0.32		305	3100	76	DC24	0.2	16
DEK-6-56	0.41		300	3000	76	/	/	16
DEK-7-01	0.45	40-160	400	1380	76	AC220	0.18	16
DEK-7-03	0.45		400	1380	76	AC380	0.18	16
DEK-7-04	0.48		400	1450	77	AC220/380	0.55	16
DEK-7-12	0.45		385	3100	78	DC12	0.2	16
DEK-7-24	0.45		385	3100	78	DC24	0.2	16
DEK-7-56	0.65		400	3000	78	/	/	16
DEK-8-01	0.69	45-180	450	1350	79	AC220	0.25	16
DEK-8-03	0.69		450	1350	79	AC380	0.25	16
DEK-8-04	0.69		450	1450	76	AC220/380	0.75	16
DEK-8-12	0.62		280	2600	79	DC12	0.2	16
DEK-8-24	0.62		280	2600	79	DC24	0.2	16
DEK-8-56	0.9		450	3000	80	/	/	16

EC series 超静音

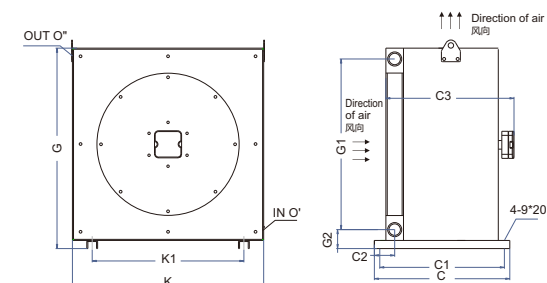

Dimensions 外形尺寸

Make sure you can select the right cooler, please contact us ※ 为保证冷却器选型的准确性, 请与迪奥公司电话联系。

Type 型号	G	K	C	G1	G2	K1	C1	C2	C3
EC2	366	335	400	289	52	160	360	58	218
EC3	466	380	450	390	54	290	410	78	310
EC4	525	485	450	439	56	425	410	78	310
EC5	567	542	540	479	57	482	500	95	423
EC6	645	522	540	500	87	482	500	95	423
EC7	740	708	540	630	70	560	500	95	423

Technical data of DEQ 技术参数

Type 型号	Voltage [V] 电压	Fan Diameter [mm] 风扇直径	Power [kW] 功率	Noise level [dB(A), 1m] 噪声
EC2	220V	225	140	68
EC3	220V/380V	315	140	64
EC4	220V/380V	355	170	67
EC5	220V/380V	400	240	68
EC6	220V/380V	450	530	76
EC7	220V/380V	450	530	76

In order to avoid cracking, when a cooler is installed in the return oil circuit, a bypass unloading valve must be parallelly connected. And make sure the unloading valve can be opened preferentially when the decompression valve reaches the pressure peak. If there is a pulse in the return oil of system or the oil flow is very big, suggest to choose the self-circulating cooling system from Deo, so that you can keep the whole system stable and reliable.

为保护冷却器不致破裂, 当冷却器安装于回油回路时, 必需加装旁通卸载阀, 与冷却器并联, 并且确认泄压阀遇压力峰值时, 能够优先打开卸载。如果系统回油有脉冲或者流量很大, 建议选用迪奥自循环冷却系统, 以保证整个系统的稳定和可靠。

DPK series

Wind cooler with bell-shaped cover
钟型罩风冷却器



Used for

DPK series of coolers are applied to overflowing rinsing cooling in closed-off system, and independently-circulating cooling system, such as products in oil, mining, vessels, heavy equipments.

Features

Arrange the cooler and bell-shaped cover together artfully, making the structure compact, and easy to install. It don't need to drive electrical motor in addition. It adopt centrifugal draught fan, with very low noise, and great wind pressure. It is suited for conditions of cabined space, where explosion-proof lights are employed. It is first choice for upgrading your products.

适用范围:

DPK系列冷却器主要运用于闭式系统的溢流冲洗冷却和有防爆要求的独立循环冷却系统。如：石油、采矿、船舶、重型设备等行业。

特点:

结构紧凑，巧妙的把冷却器与钟型罩合二为一，安装方便。无须另外驱动电机。采用离心式风机，噪音低，风压大。特别适合空间狭窄、防爆灯场合使用，是您产品升级的首选。

DPK series structure 构造

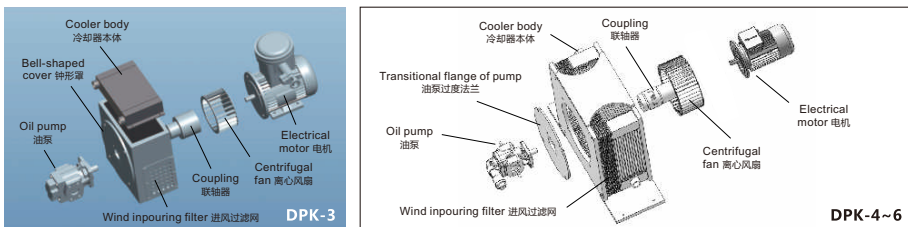

Instructions of DPK 型号说明

DPK-4-R-160-F-10-EX

1 2 3 4 5 6 7

- Serial number:** DPK bell-shaped cover cooler
- Sizes of coolers:** 3, 4, 5, 6
- Rotating directions of wind blades**
Right-rotating (clockwise) = R
Left-rotating (anticlockwise) = L
- Numbers of electrical motor base**
- Filter:** F = with filter, None = without filter
- Precision of filter:** 10μm=10, 20μm=20
- Applicable conditions**
Not explosion-proof = None
Exd I explosion-proof = EX
Exd II explosion-proof = EX2

- 系列号:** DPK钟罩冷却器
- 冷却器尺寸:** 3, 4, 5, 6
- 风叶旋向:** 右旋(顺时针) = R
左旋(逆时针) = L
- 电机机座号**
- 过滤器:** F = 含过滤器, 无 = 无过滤器
- 过滤器精度:** 10μm=10, 20μm=20
- 适用工况:** 非防爆 = 无
Exd I 类防爆 = EX
Exd II 类防爆 = EX2

Please offer additional drawings about installing sizes of oil pump axis
Attention: If there is any special request, please tell us in speech.

油泵轴安装尺寸请附图纸
注: 如有特殊要求请用明语说明!

Performance curve & dimension of DPK 性能曲线和外形尺寸

Performance curve 性能曲线

Input parameter of performance curve
Quality of oil : ISO VG46
Temperature of inpouring oil : 60°C

性能曲线输入参数
油品 : ISO VG46
进油温度 : 60°C

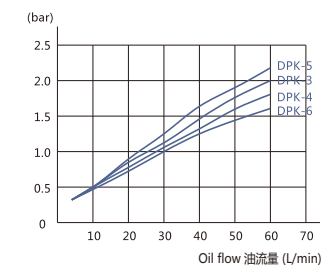
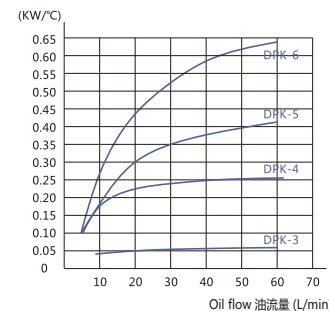

Dimension 外形尺寸

DPK-3

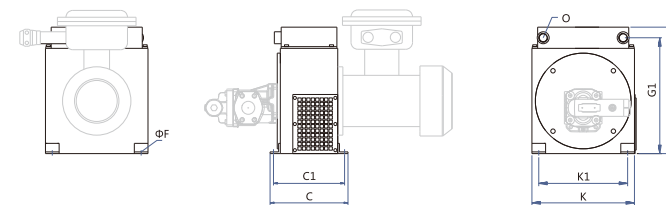

DPK-4~6

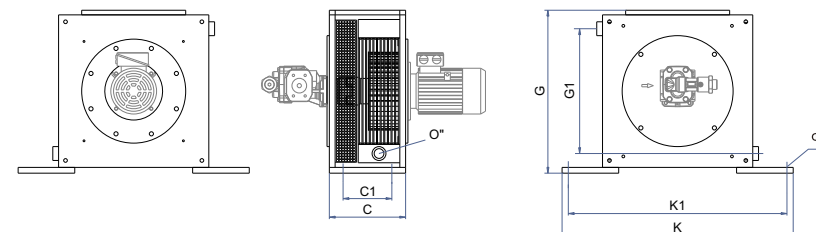

Type 型号	G(mm)	K(mm)	C(mm)	G1(mm)	K1(mm)	C1(mm)	O	ΦF(mm)	P	Power(kw) 功率
DPK-3	370	300	228	339	260	208	G3/4"	12	4	0.37~4
DPK-4	500	470	430	455	390	385	G1"	18	4	5.5~22
DPK-5	705	650	470	625	580	400	G1"	20	4	30~55
DPK-6	765	690	470	625	620	400	G1"	20	4	55~90

» AH0608T



Curve of heat abstraction quantity
散热量曲线

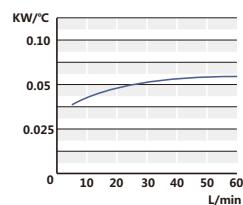

Curve of pressure loss
压力损失曲线

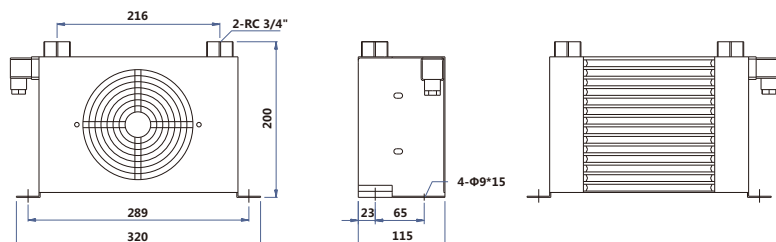
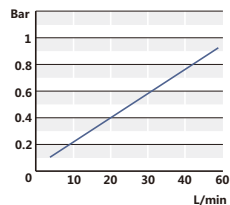

Type 型号	Flux [L/min] 流量	Motor Voltage [V] 电机电压	Frequency [Hz] 频率	Consumed Power [kW] 消耗功率	Fan speed [rpm] 风扇转速	Noise level [dB(A),1m] 噪声	Working Pressure [bar] 工作压力
AH0608T-CA3	3~60	2 ϕ 380	50/60	35	2850/3450	64	20
AH0608T-CA2		2 ϕ 220	50/60	35	2850/3450	64	20
AH0608T-CA1		2 ϕ 110	50/60	35	2850/3450	64	20
AH0608T-CD1		DC 12V	/	20	3000	64	20
AH0608T-CD2		DC 24V	/	20	3000	64	20

In order to avoid cracking , when a cooler is installed in the return oil circuit, a bypass unloading valve must be parallelly connected. And make sure the unloading valve can be opened preferentially when the decompression valve reaches the pressure peak. If there is a pulse in the return oil of system or the oil flow is very big, suggest to choose the self-circulating cooling system from Deo, so that you can keep the whole system stable and reliable.

为保护冷却器不致破裂，当冷却器安装于回油回路时，必需加装旁通卸载阀，与冷却器并联，并且确认泄压阀遭遇压力峰值时，能够优先打开卸载。如果系统回油有脉冲或者流量很大，建议选用迪奥自循环冷却系统，以保证整个系统的稳定和可靠。

» AH0608LT



Curve of heat abstraction quantity
散热量曲线

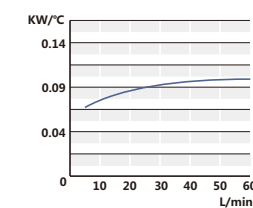

Curve of pressure loss
压力损失曲线

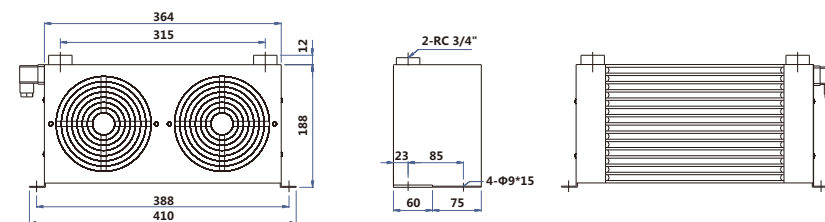
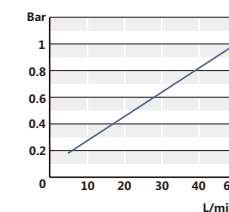

Type 型号	Flux [L/min] 流量	Motor Voltage [V] 电机电压	Frequency [Hz] 频率	Consumed Power [kW] 消耗功率	Fan speed [rpm] 风扇转速	Noise level [dB(A),1m] 噪声	Working Pressure [bar] 工作压力
AH0608LT-CA3	3~60	2 ϕ 380	50/60	35*2	2850/3450	64	20
AH0608LT-CA2		2 ϕ 220	50/60	35*2	2850/3450	64	20
AH0608LT-CA1		2 ϕ 110	50/60	35*2	2850/3450	64	20
AH0608LT-CD1		DC 12V	/	20*2	3000	64	20
AH0608LT-CD2		DC 24V	/	20*2	3000	64	20

In order to avoid cracking , when a cooler is installed in the return oil circuit, a bypass unloading valve must be parallelly connected. And make sure the unloading valve can be opened preferentially when the decompression valve reaches the pressure peak. If there is a pulse in the return oil of system or the oil flow is very big, suggest to choose the self-circulating cooling system from Deo, so that you can keep the whole system stable and reliable.

为保护冷却器不致破裂，当冷却器安装于回油回路时，必需加装旁通卸载阀，与冷却器并联，并且确认泄压阀遭遇压力峰值时，能够优先打开卸载。如果系统回油有脉冲或者流量很大，建议选用迪奥自循环冷却系统，以保证整个系统的稳定和可靠。

» AH1012



Curve of heat abstraction quantity
散热量曲线

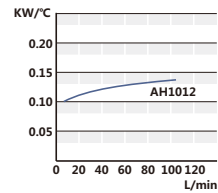

Curve of pressure loss
压力损失曲线

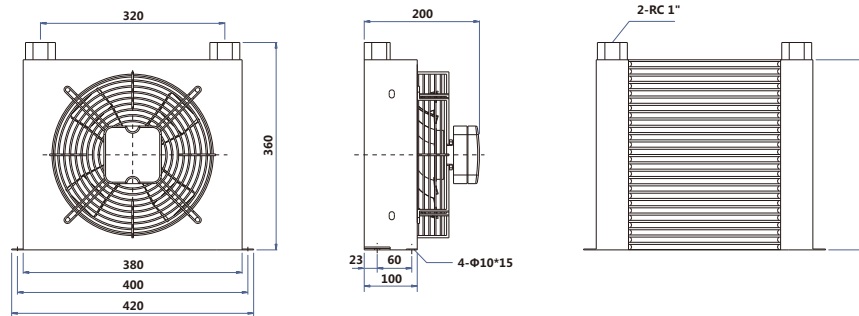
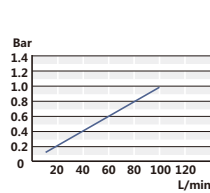

Type 型号	Flux [L/min] 流量	Motor Voltage [V] 电机电压	Frequency [Hz] 频率	Consumed Power [kW] 消耗功率	Fan speed [rpm] 风扇转速	Noise level [dB(A),1m] 噪声	Working Pressure [bar] 工作压力
AH1012-CA3	20~100	3 Φ 380	50/60	60/65	1380/1550	55	20
AH1012-CA2		2 Φ 220	50/60	60/65	1380/1550	55	20
AH1012-CA1		2 Φ 110	50/60	120/140	1380/1550	55	20
AH1012-CD1		DC 12V	/	150	2000	60	20
AH1012-CD2		DC 24V	/	150	2400	60	20

In order to avoid cracking , when a cooler is installed in the return oil circuit, a bypass unloading valve must be parallelly connected. And make sure the unloading valve can be opened preferentially when the decompression valve reaches the pressure peak. If there is a pulse in the return oil of system or the oil flow is very big, suggest to choose the self-circulating cooling system from Deo, so that you can keep the whole system stable and reliable.

为保护冷却器不致破裂，当冷却器安装于回油回路时，必需加装旁通卸载阀，与冷却器并联，并且确认泄压阀遭遇压力峰值时，能够优先打开卸载。如果系统回油有脉冲或者流量很大，建议选用迪奥自循环冷却系统，以保证整个系统的稳定和可靠。

» AH1215



Curve of heat abstraction quantity
散热量曲线

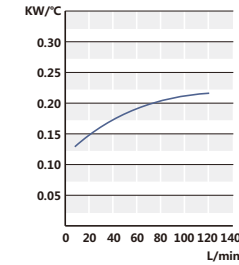

Curve of pressure loss
压力损失曲线

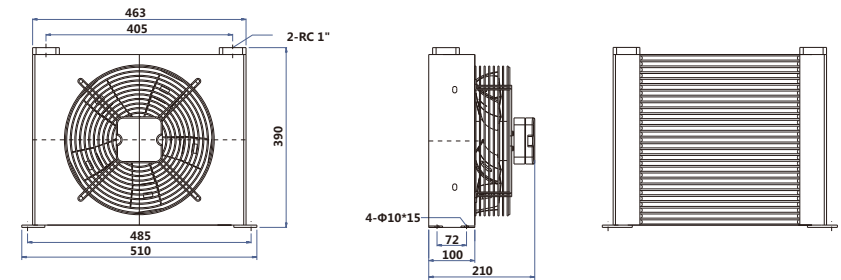
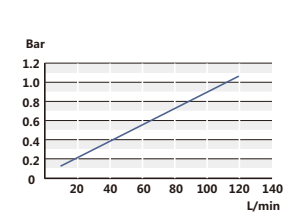

Type 型号	Flux [L/min] 流量	Motor Voltage [V] 电机电压	Frequency [Hz] 频率	Consumed Power [kW] 消耗功率	Fan speed [rpm] 风扇转速	Noise level [dB(A),1m] 噪声	Working Pressure [bar] 工作压力
AH1215-CA3	20~100	3 Φ 380	50/60	80/86	1380/1550	65	20
AH1215-CA2		2 Φ 220	50/60	80/86	1380/1550	65	20
AH1215-CD1		DC 12V	/	200	3000	76	20
AH1215-CD2		DC 24V	/	200	3000	76	20

In order to avoid cracking , when a cooler is installed in the return oil circuit, a bypass unloading valve must be parallelly connected. And make sure the unloading valve can be opened preferentially when the decompression valve reaches the pressure peak. If there is a pulse in the return oil of system or the oil flow is very big, suggest to choose the self-circulating cooling system from Deo, so that you can keep the whole system stable and reliable.

为保护冷却器不致破裂，当冷却器安装于回油回路时，必需加装旁通卸载阀，与冷却器并联，并且确认泄压阀遭遇压力峰值时，能够优先打开卸载。如果系统回油有脉冲或者流量很大，建议选用迪奥自循环冷却系统，以保证整个系统的稳定和可靠。

» AH1417 AH1470



Curve of heat abstraction quantity
散热量曲线

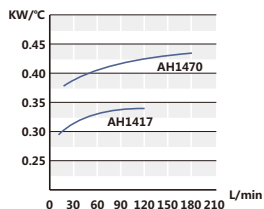

Curve of pressure loss
压力损失曲线

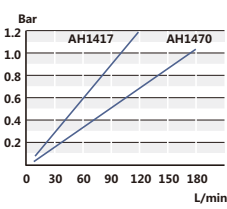

Type	A	B	C
AH1417	45	2-RC 1"	48
AH1470	70	2-RC 1-1/4"	50

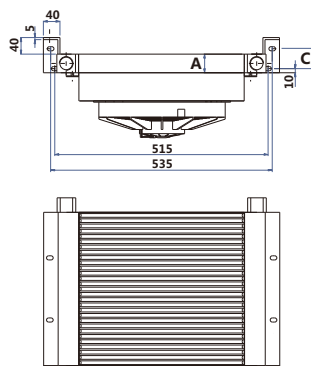
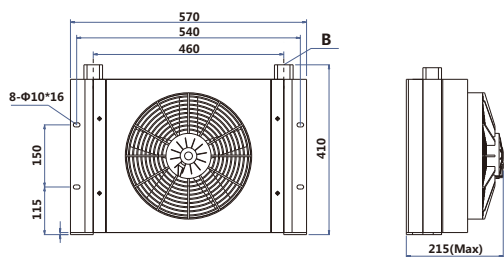

Type 型号	Flux [L/min] 流量	Motor Voltage [V] 电机电压	Frequency [Hz] 频率	Consumed Power [kW] 消耗功率	Fan speed [rpm] 风扇转速	Noise level [dB(A),1m] 噪声	Working Pressure [bar] 工作压力
AH1417/1470-A3	30~100	3 φ 380	50/60	80/160	1380/1550	67	20
AH1417/1470-A2		2 φ 220	50/60	80/160	1380/1550	67	20
AH1417/1470-A1		2 φ 110	50/60	180/190	1380/1550	67	20
AH1417/1470-D1		DC 12V	/	200	3000	67	20
AH1417/1470-D2		DC 24V	/	200	3000	67	20

In order to avoid cracking, when a cooler is installed in the return oil circuit, a bypass unloading valve must be parallelly connected. And make sure the unloading valve can be opened preferentially when the decompression valve reaches the pressure peak. If there is a pulse in the return oil of system or the oil flow is very big, suggest to choose the self-circulating cooling system from Deo, so that you can keep the whole system stable and reliable.

为保护冷却器不致破裂，当冷却器安装于回油回路时，必需加装旁通卸载阀，与冷却器并联，并且确认泄压阀遭遇压力峰值时，能够优先打开卸载。如果系统回油有脉冲或者流量很大，建议选用迪奥自循环冷却系统，以保证整个系统的稳定和可靠。

» AH1418



Curve of heat abstraction quantity
散热量曲线

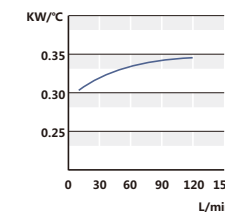

Curve of pressure loss
压力损失曲线

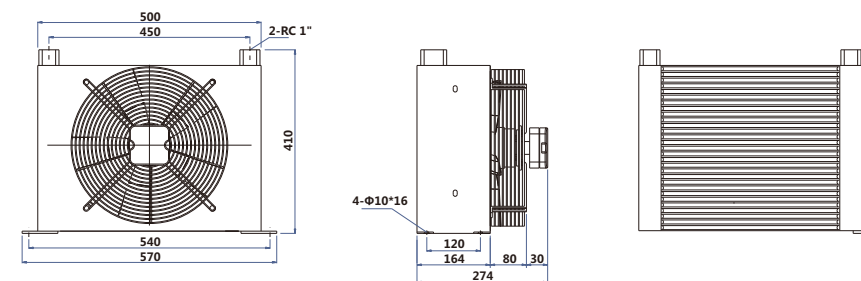
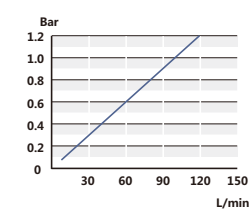

Type 型号	Flux [L/min] 流量	Motor Voltage [V] 电机电压	Frequency [Hz] 频率	Consumed Power [kW] 消耗功率	Fan speed [rpm] 风扇转速	Noise level [dB(A),1m] 噪声	Working Pressure [bar] 工作压力
AH1418-CA2	30~100	2 φ 220	50/60	140/160	1380/1550	67	20
AH1418-CA3		3 φ 380	50/60	140/160	1380/1550	67	20

In order to avoid cracking, when a cooler is installed in the return oil circuit, a bypass unloading valve must be parallelly connected. And make sure the unloading valve can be opened preferentially when the decompression valve reaches the pressure peak. If there is a pulse in the return oil of system or the oil flow is very big, suggest to choose the self-circulating cooling system from Deo, so that you can keep the whole system stable and reliable.

为保护冷却器不致破裂，当冷却器安装于回油回路时，必需加装旁通卸载阀，与冷却器并联，并且确认泄压阀遭遇压力峰值时，能够优先打开卸载。如果系统回油有脉冲或者流量很大，建议选用迪奥自循环冷却系统，以保证整个系统的稳定和可靠。

» AH1428



Curve of heat abstraction quantity
散热量曲线

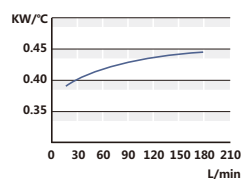

Curve of pressure loss
压力损失曲线

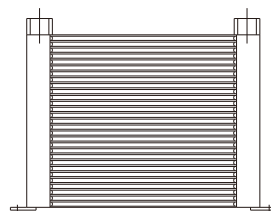
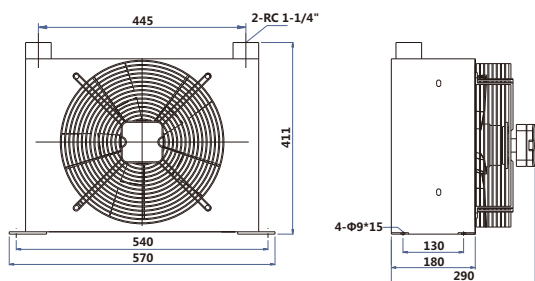
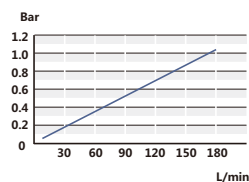

Type 型号	Flux [L/min] 流量	Motor Voltage [V] 电机电压	Frequency [Hz] 频率	Consumed Power [kW] 消耗功率	Fan speed [rpm] 风扇转速	Noise level [dB(A), 1m] 噪声	Working Pressure [bar] 工作压力
AH1428-CA2	30~150	2 ϕ 220	50/60	140/160	1380/1550	67	20
AH1428-CA3		3 ϕ 380	50/60	140/160	1380/1550	67	20
AH1428-CA4		3 ϕ 440	50/60	140/160	1380/1550	67	20

In order to avoid cracking, when a cooler is installed in the return oil circuit, a bypass unloading valve must be parallelly connected. And make sure the unloading valve can be opened preferentially when the decompression valve reaches the pressure peak. If there is a pulse in the return oil of system or the oil flow is very big, suggest to choose the self-circulating cooling system from Deo, so that you can keep the whole system stable and reliable.

为保护冷却器不致破裂，当冷却器安装于回油回路时，必需加装旁通卸载阀，与冷却器并联，并且确认泄压阀遭遇压力峰值时，能够优先打开卸载。如果系统回油有脉冲或者流量很大，建议选用迪奥自循环冷却系统，以保证整个系统的稳定和可靠。

» AH1490



Curve of heat abstraction quantity
散热量曲线

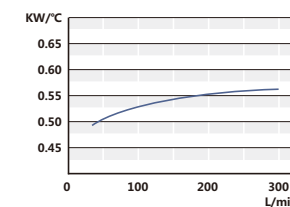

Curve of pressure loss
压力损失曲线

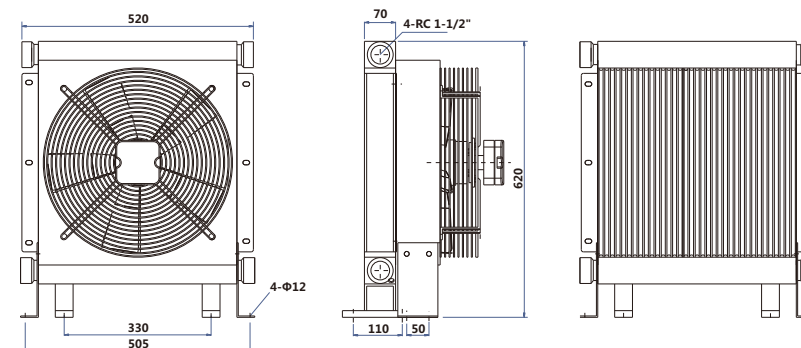
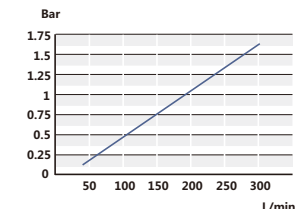

Type 型号	Flux [L/min] 流量	Motor Voltage [V] 电机电压	Frequency [Hz] 频率	Consumed Power [kW] 消耗功率	Fan speed [rpm] 风扇转速	Noise level [dB(A), 1m] 噪声	Working Pressure [bar] 工作压力
AH1490-CA2	30~200	2 ϕ 220	50/60	180/190	1380/1550	71	20
AH1490-CA3		3 ϕ 380	50/60	180/190	1380/1550	71	20
AH1490-CA4		3 ϕ 440	50/60	180/190	1380/1550	71	20

In order to avoid cracking, when a cooler is installed in the return oil circuit, a bypass unloading valve must be parallelly connected. And make sure the unloading valve can be opened preferentially when the decompression valve reaches the pressure peak. If there is a pulse in the return oil of system or the oil flow is very big, suggest to choose the self-circulating cooling system from Deo, so that you can keep the whole system stable and reliable.

为保护冷却器不致破裂，当冷却器安装于回油回路时，必需加装旁通卸载阀，与冷却器并联，并且确认泄压阀遭遇压力峰值时，能够优先打开卸载。如果系统回油有脉冲或者流量很大，建议选用迪奥自循环冷却系统，以保证整个系统的稳定和可靠。

» AH1680



Curve of heat abstraction quantity
散热量曲线

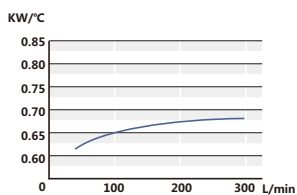

Curve of pressure loss
压力损失曲线

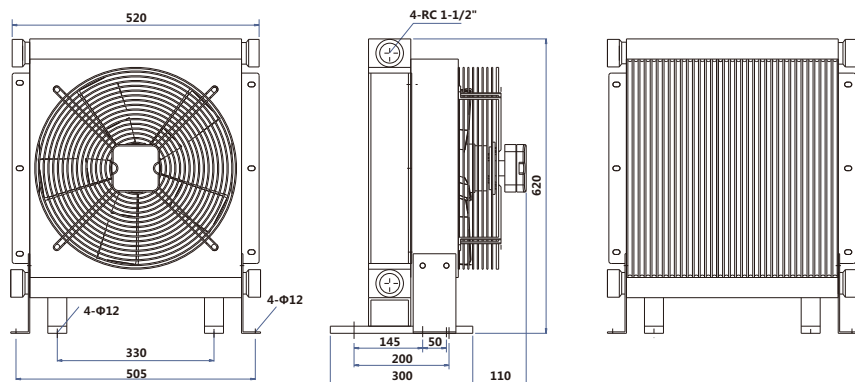
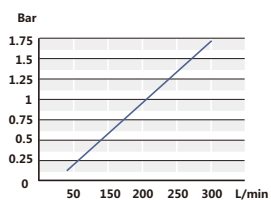

Type 型号	Flux [L/min] 流量	Motor Voltage [V] 电机电压	Frequency [Hz] 频率	Consumed Power [kW] 消耗功率	Fan speed [rpm] 风扇转速	Noise level [dB(A),1m] 噪声	Working Pressure [bar] 工作压力
AH1680-CA2	30~250	2 φ 220	50/60	180/190	1380/1550	71	20
AH1680-CA3		3 φ 380	50/60	180/190	1380/1550	71	20
AH1680-CA4		3 φ 440	50/60	180/190	1380/1550	71	20

In order to avoid cracking , when a cooler is installed in the return oil circuit, a bypass unloading valve must be parallelly connected. And make sure the unloading valve can be opened preferentially when the decompression valve reaches the pressure peak. If there is a pulse in the return oil of system or the oil flow is very big, suggest to choose the self-circulating cooling system from Deo, so that you can keep the whole system stable and reliable.

为保护冷却器不致破裂，当冷却器安装于回油回路时，必需加装旁通卸载阀，与冷却器并联，并且确认泄压阀遭遇压力峰值时，能够优先打开卸载。如果系统回油有脉冲或者流量很大，建议选用迪奥自循环冷却系统，以保证整个系统的稳定和可靠。

» AH1890

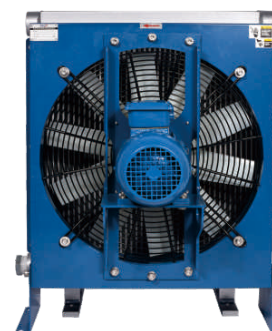

Curve of heat abstraction quantity
散热量曲线

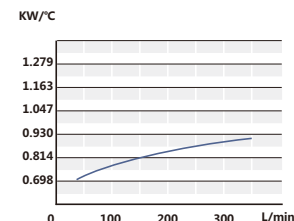

Curve of pressure loss
压力损失曲线

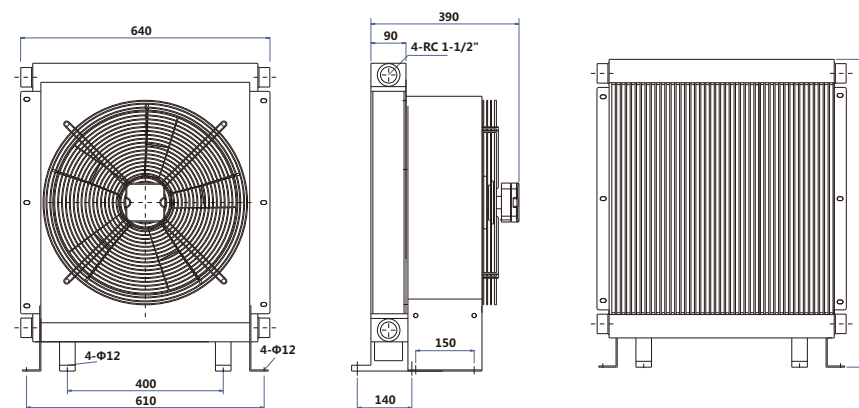
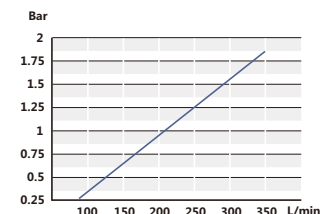

Type 型号	Flux [L/min] 流量	Motor Voltage [V] 电机电压	Frequency [Hz] 频率	Consumed Power [kW] 消耗功率	Fan speed [rpm] 风扇转速	Noise level [dB(A),1m] 噪声	Working Pressure [bar] 工作压力
AH1890-CA2	30~250	2 φ 220	50/60	450	1380/1550	79	20
AH1890-CA3		3 φ 380	50/60	450	1380/1550	79	20
AH1890-CA4		3 φ 440	50/60	450	1380/1550	79	20
AH1890A-CA3		3 φ 380	50/60	750	1450/1600	79	20

In order to avoid cracking , when a cooler is installed in the return oil circuit, a bypass unloading valve must be parallelly connected. And make sure the unloading valve can be opened preferentially when the decompression valve reaches the pressure peak. If there is a pulse in the return oil of system or the oil flow is very big, suggest to choose the self-circulating cooling system from Deo, so that you can keep the whole system stable and reliable.

为保护冷却器不致破裂，当冷却器安装于回油回路时，必需加装旁通卸载阀，与冷却器并联，并且确认泄压阀遭遇压力峰值时，能够优先打开卸载。如果系统回油有脉冲或者流量很大，建议选用迪奥自循环冷却系统，以保证整个系统的稳定和可靠。

» AH2342



Curve of heat abstraction quantity
散热量曲线

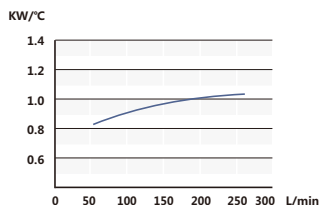

Curve of pressure loss
压力损失曲线

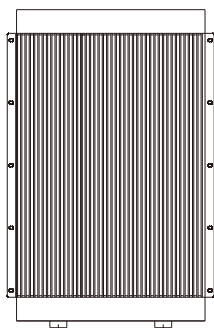
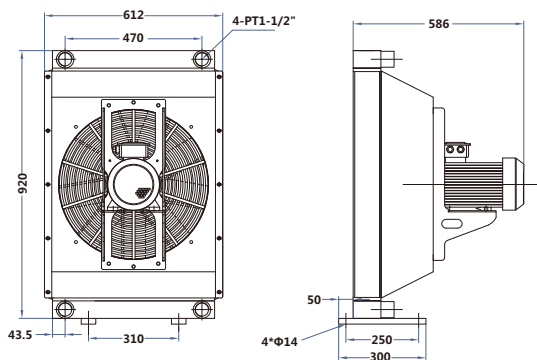
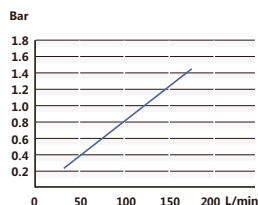

Type 型号	Flux [L/min] 流量	Motor Voltage [V] 电机电压	Frequency [Hz] 频率	Consumed Power [kW] 消耗功率	Fan speed [rpm] 风扇转速	Noise level [dB(A), 1m] 噪声	Working Pressure [bar] 工作压力
AH2342-CA2	50~250	2 φ 220	50/60	450	1380/1550	79	20
AH2342-CA3		3 φ 380	50/60	450	1380/1550	79	20
AH2342-CA4		3 φ 440	50/60	450	1380/1550	79	20
AH2342A-CA3		3 φ 380	50/60	750	1450/1600	79	20

In order to avoid cracking, when a cooler is installed in the return oil circuit, a bypass unloading valve must be parallelly connected. And make sure the unloading valve can be opened preferentially when the decompression valve reaches the pressure peak. If there is a pulse in the return oil of system or the oil flow is very big, suggest to choose the self-circulating cooling system from Deo, so that you can keep the whole system stable and reliable.

为保护冷却器不致破裂，当冷却器安装于回油回路时，必需加装旁通卸载阀，与冷却器并联，并且确认泄压阀遭遇压力峰值时，能够优先打开卸载。如果系统回油有脉冲或者流量很大，建议选用迪奥自循环冷却系统，以保证整个系统的稳定和可靠。

» AHL608 Only applied to coolers at oil outlet of vane pumps 此机型只适用于叶片泵泄油口冷却器



Type 型号	A (RC)	B (mm)	C (mm)	D (mm)	E (mm)	F (mm)	WEIGHT 重量(Kg)
AHL608	3/8"	32	58	217	205	250	0.75

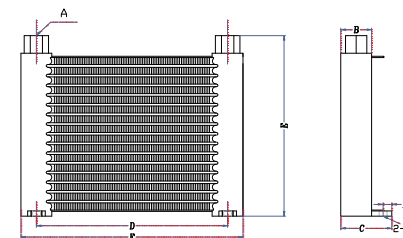

Curve of pressure loss
压力损失曲线

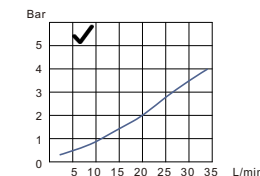

» AHL608-A(D) Only applied to coolers at the oil outlet of vane pumps 此机型只适用于叶片泵泄油口冷却器

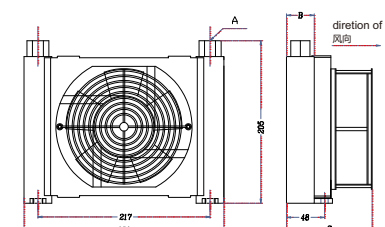

Type 型号	A (RC)	B (mm)	C (mm)	WEIGHT 重量(Kg)
AHL608-A	3/8"	32	103	2

Type 型号	Flux [L/min] 流量	Motor Voltage [V] 电机电压	Frequency [Hz] 频率	Consumed Power [kW] 消耗功率	Fan speed [rpm] 风扇转速	Noise level [dB(A), 1m] 噪声	Working Pressure [bar] 工作压力
AHL608-A3	1~30 (Recommended flux: 0~10)	2 φ 380	50/60	35	2850/3450	64	20
AHL608-A2		2 φ 220	50/60	35	2850/3450	64	20
AHL608-A1		2 φ 110	50/60	35	2850/3450	64	20
AHL608-D1		DC 12V	/	20	3000	64	20
AHL608-D2		DC 24V	/	20	3000	64	20

» AHL608-2A(2D)

Only applied to coolers at oil outlet of vane pumps
此机型只适用于叶片泵泄油口冷却器

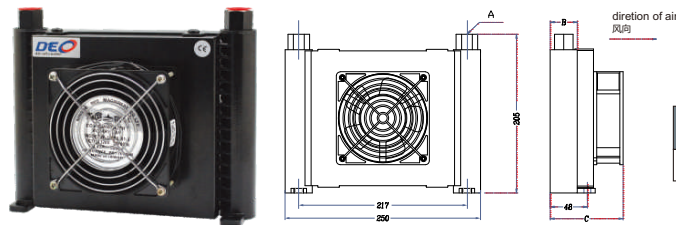

Type 型号	A (RC)	B (mm)	C (mm)	WEIGHT 重量(Kg)
AHL608-2A	3/8"	32	94	2.3

Type 型号	Flux [L/min] 流量	Motor Voltage [V] 电机电压	Frequency [Hz] 频率	Consumed Power [kW] 消耗功率	Fan speed [rpm] 风扇转速	Noise level [dB(A), 1m] 噪声	Working Pressure [bar] 工作压力
AHL608-2A3	1~30 (Recommended flux 0~10)	2 φ 380	50/60	35	2850/3450	64	20
AHL608-2A2		2 φ 220	50/60	35	2850/3450	64	20
AHL608-2A1		2 φ 110	50/60	35	2850/3450	64	20
AHL608-2D1		DC 12V	/	20	3000	64	20
AHL608-2D2		DC 24V	/	20	3000	64	20

» AHL608-4A(4D)

Only applied to coolers at the oil outlet of vane pumps
此机型只适用于叶片泵泄油口冷却器

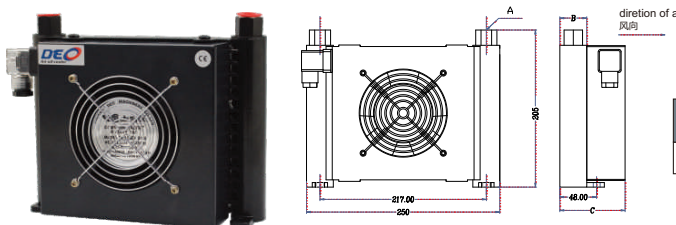

Type 型号	A (RC)	B (mm)	C (mm)	WEIGHT 重量(Kg)
AHL608-4A	3/8"	32	90	1.5

Type 型号	Flux [L/min] 流量	Motor Voltage [V] 电机电压	Frequency [Hz] 频率	Consumed Power [kW] 消耗功率	Fan speed [rpm] 风扇转速	Noise level [dB(A), 1m] 噪声	Working Pressure [bar] 工作压力
AHL608-4A3	1~30 (Recommended flux 0~10)	2 φ 380	50/60	12	2850/3450	64	20
AHL608-4A2		2 φ 220	50/60	12	2850/3450	64	20
AHL608-4A1		2 φ 110	50/60	12	2850/3450	64	20
AHL608-4D1		DC 12V	/	12	3000	64	20
AHL608-4D2		DC 24V	/	12	3000	64	20

» AW0607



Curve of heat abstraction quantity
散热量曲线

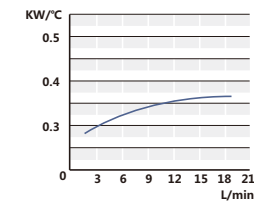

Curve of pressure loss
压力损失曲线

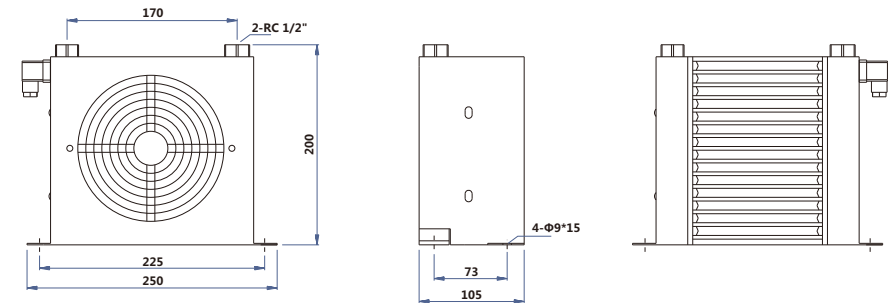
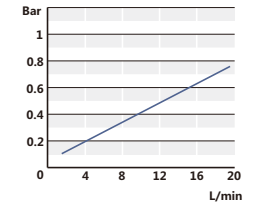

Type 型号	Flux [L/min] 流量	Motor Voltage [V] 电机电压	Frequency [Hz] 频率	Consumed Power [kW] 消耗功率	Fan speed [rpm] 风扇转速	Noise level [dB(A), 1m] 噪声	Working Pressure [bar] 工作压力
AW0607-CA3	1~20	2 φ 380	50/60	35	2850/3450	64	20
AW0607-CA2		2 φ 220	50/60	35	2850/3450	64	20
AW0607-CA1		2 φ 110	50/60	35	2850/3450	64	20
AW0607-CD1		DC 12V	/	20	3000	64	20
AW0607-CD2		DC 24V	/	20	3000	64	20

In order to avoid cracking, when a cooler is installed in the return oil circuit, a bypass unloading valve must be parallelly connected. And make sure the unloading valve can be opened preferentially when the decompression valve reaches the pressure peak. If there is a pulse in the return oil of system or the oil flow is very big, suggest to choose the self-circulating cooling system from Deo, so that you can keep the whole system stable and reliable.

为保护冷却器不致破裂, 当冷却器安装于回油回路时, 必需加装旁通卸载阀, 与冷却器并联, 并且确认泄压阀遭遇压力峰值时, 能够优先打开卸载。如果系统回油有脉冲或者流量很大, 建议选用迪奥自循环冷却系统, 以保证整个系统的稳定和可靠。

AW0608



Curve of heat abstraction quantity
散热量曲线

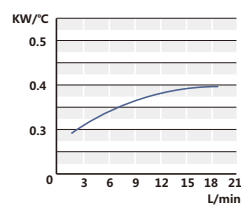

Curve of pressure loss
压力损失曲线

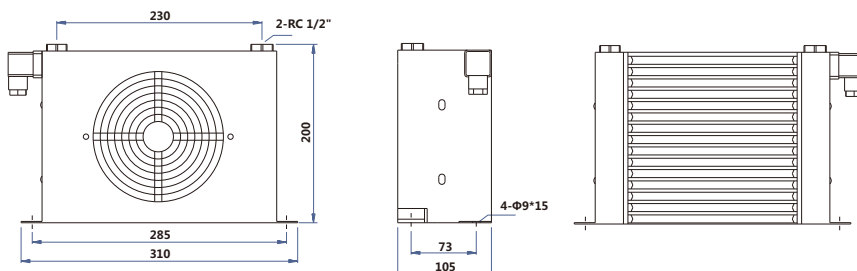
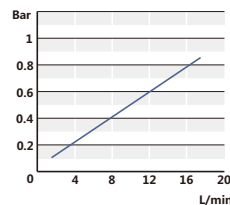

Type 型号	Flux [L/min] 流量	Motor Voltage [V] 电机电压	Frequency [Hz] 频率	Consumed Power [kW] 消耗功率	Fan speed [rpm] 风扇转速	Noise level [dB(A),1m] 噪声	Working Pressure [bar] 工作压力
AW0608-CA3	1~20	2 φ 380	50/60	35	2850/3450	64	20
AW0608-CA2		2 φ 220	50/60	35	2850/3450	64	20
AW0608-CA1		2 φ 110	50/60	35	2850/3450	64	20
AW0608-CD1		DC 12V	/	20	3000	64	20
AW0608-CD2		DC 24V	/	20	3000	64	20

In order to avoid cracking, when a cooler is installed in the return oil circuit, a bypass unloading valve must be parallelly connected. And make sure the unloading valve can be opened preferentially when the decompression valve reaches the pressure peak. If there is a pulse in the return oil of system or the oil flow is very big, suggest to choose the self-circulating cooling system from Deo, so that you can keep the whole system stable and reliable.

为保护冷却器不致破裂，当冷却器安装于回油回路时，必需加装旁通卸载阀，与冷却器并联，并且确认泄压阀遭遇压力峰值时，能够优先打开卸载。如果系统回油有脉冲或者流量很大，建议选用迪奥自循环冷却系统，以保证整个系统的稳定和可靠。

AW0608L



Curve of heat abstraction quantity
散热量曲线

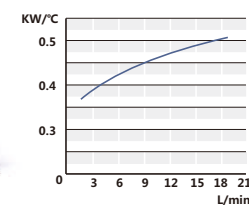

Curve of pressure loss
压力损失曲线

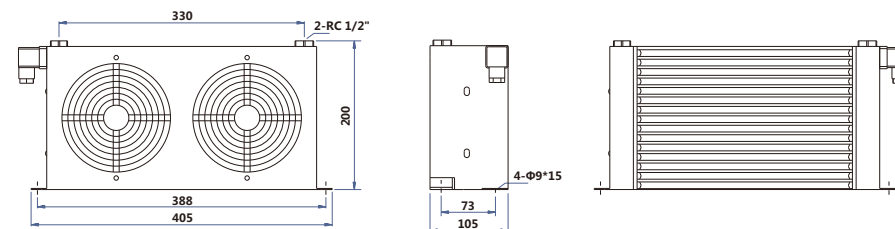
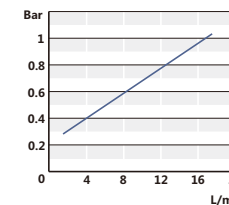

Type 型号	Flux [L/min] 流量	Motor Voltage [V] 电机电压	Frequency [Hz] 频率	Consumed Power [kW] 消耗功率	Fan speed [rpm] 风扇转速	Noise level [dB(A),1m] 噪声	Working Pressure [bar] 工作压力
AW0608L-CA3	1~20	2 φ 380	50/60	35*2	2850/3450	64	20
AW0608L-CA2		2 φ 220	50/60	35*2	2850/3450	64	20
AW0608L-CA1		2 φ 110	50/60	35*2	2850/3450	64	20
AW0608L-CD1		DC 12V	/	20*2	3000	64	20
AW0608L-CD2		DC 24V	/	20*2	3000	64	20

In order to avoid cracking, when a cooler is installed in the return oil circuit, a bypass unloading valve must be parallelly connected. And make sure the unloading valve can be opened preferentially when the decompression valve reaches the pressure peak. If there is a pulse in the return oil of system or the oil flow is very big, suggest to choose the self-circulating cooling system from Deo, so that you can keep the whole system stable and reliable.

为保护冷却器不致破裂，当冷却器安装于回油回路时，必需加装旁通卸载阀，与冷却器并联，并且确认泄压阀遭遇压力峰值时，能够优先打开卸载。如果系统回油有脉冲或者流量很大，建议选用迪奥自循环冷却系统，以保证整个系统的稳定和可靠。

» AHS628 AHS630

Mainly applied to cooling of principal axis, low temperature cooling system of small fluxes.
主要适用于主轴冷却、小流量低温度冷却系统

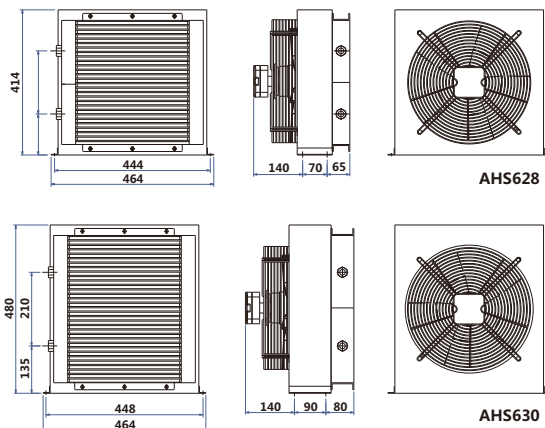

Contact Us For More Information:

Changzhou ADV Heat Exchanger Co., Ltd

No.29 Xuema Road, Xueyan, Wujin District,
213169 Changzhou, Jiangsu

Tel: +86-519-85181789

Cell: (+86)135 8426 7707

Email: Sales@advcooler.com

Type 型号	Flux [L/min] 流量	Motor Voltage [V] 电机电压	Frequency [Hz] 频率	Consumed Power [kW] 消耗功率	Fan speed [rpm] 风扇转速	Noise level [dB(A), 1m] 噪声	Working Pressure [bar] 工作压力
AHS628-CA2	20~100	2 φ 380	50/60	80	1380/1600	65	20
AHS628-CA3		2 φ 220	50/60	80	1380/1600	65	20
AHS628-CD1		DC 12V	/	200	3000	76	20
AHS628-CD2		DC 24V	/	200	3000	76	20

Type 型号	Flux [L/min] 流量	Motor Voltage [V] 电机电压	Frequency [Hz] 频率	Consumed Power [kW] 消耗功率	Fan speed [rpm] 风扇转速	Noise level [dB(A), 1m] 噪声	Working Pressure [bar] 工作压力
AHS630-CA2	20~100	2 φ 380	50/60	80	1380/1600	65	20
AHS630-CA3		2 φ 220	50/60	80	1380/1600	65	20
AHS630-CD1		DC 12V	/	200	3000	76	20
AHS630-CD2		DC 24V	/	200	3000	76	20

In order to avoid cracking, when a cooler is installed in the return oil circuit, a bypass unloading valve must be parallelly connected. And make sure the unloading valve can be opened preferentially when the decompression valve reaches the pressure peak. If there is a pulse in the return oil of system or the oil flow is very big, suggest to choose the self-circulating cooling system from Deo, so that you can keep the whole system stable and reliable.

为保护冷却器不致破裂，当冷却器安装于回油回路时，必需加装旁通卸载阀，与冷却器并联，并且确认泄压阀遭遇压力峰值时，能够优先打开卸载。如果系统回油有脉冲或者流量很大，建议选用迪奥自循环冷却系统，以保证整个系统的稳定和可靠。